

Report of the
International Research Training Group
**Development and Application of
Intelligent Detectors**
at the



Ruprecht-Karls-Universität Heidelberg, Germany
Prof. Dr. N. Herrmann
University of Mannheim, Germany



University of Bergen, Norway
Prof. Dr. D. Röhrich
University of Oslo, Norway

Anticipated funding period: 01.04.2004 – 30.09.2008
Actual funding period: 01.10.2004 – 31.03.2009
Submission date: 01.04.2008
Heidelberg,

Inhaltsverzeichnis

1	General Information	4
1.1	Program Title	4
1.2	Participating Scientist	4
1.3	Report period	8
1.4	Number of Stipends	8
1.5	Web page address	8
2	Research Program	9
2.1	List of stipends	14
2.2	Reports of the stipendiaries	21
2.2.1	Report by stipendiary Aleksandra Adametz	21
2.2.2	Report by stipendiary Torsten Alt	24
2.2.3	Report by stipendiary George V. Andrei	26
2.2.4	Report by stipendiary Barbara Böhm	31
2.2.5	Report by stipendiary Jan de Cuveland	34
2.2.6	Report by stipendiary David Emschermann	36
2.2.7	Report by stipendiary Andreas W. Jung	39
2.2.8	Report by stipendiary Jan Knopf	43
2.2.9	Report by stipendiary Andreas Reischl	46
2.2.10	Report by stipendiary Felix Rettig	49
2.2.11	Report by stipendiary Frederik Rühr	50
2.2.12	Report by stipendiary Rachik Soualah	54
2.2.13	Report by stipendiary Jochen Thäder	57
2.2.14	Report by stipendiary Gerd Tröger	58
3	Study Program	62
3.1	Key skills seminars	63
3.2	Activities	64
3.3	Contacts to Abroad	64
4	Visiting scientist program	65
5	Organizational Structure	66

INHALTSVERZEICHNIS

6	Infrastructure	67
7	Interim Result	69
A	Programs of IRTG activities	70
B	List of Contacts to Abroad	103

Kapitel 1

General Information

1.1 Program Title

“Entwicklung und Anwendung von intelligenten Detektoren”
“Development and application of intelligent detectors”

1.2 Participating Scientist

Name, Vorname, akad. Titel	Lehrstuhl / Institut Dienstanschrift	Telefon / Faxnummer, Email, Internet	Fachgebiet
Herrmann, Norbert , (speaker) Prof. Dr.	Physikalisches Institut Philosophenweg 12 69121 Heidelberg	06221-549464/475733, herrmann@physi.uni-heidelberg.de http://www.physi.uni-heidelberg.de	Heavy Ion FOPI, CBM
Röhrich, Dieter, Prof. Dr.	Department of Physics University of Bergen Allegaten 55 5007 Bergen, Norway	+47-555-82722/89440 Dieter.Rohrich@fi.uib.no	 ALICE, CBM
Eisele, Franz, Prof. Dr.	Physikalisches Institut,	+49-6221-549215 eisele@physi.uni-heidelberg.de	High Energy H1
Kebschull, Udo, Prof. Dr.	Kirchhoff-Institut für Physik	+49-6221-549802 kebschull@kip.uni-heidelberg.de	Computer Engineering ALICE, CBM
Lindenstruth, Volker, Prof. Dr.	Kirchhoff-Institut für Physik	+49-6221-549464 ti@kip.uni-heidelberg.de	Computer Engineering ALICE, CBM
Meier, Karlheinz, Prof. Dr.	Kirchhoff-Institut für Physik	+49-6221-549831 meierk@kip.uni-heidelberg.de	Computer Engineering ATLAS
Schultz-Coulon, Christian, Prof. Dr.	Kirchhoff-Institut für Physik	+49-6221-549281 schultz-coulon@kip.uni-heidelberg.de	High Energy ATLAS, H1, ILC

Stachel, Johanna, Prof. Dr.	Physikalisches Institut,	+49 6221-549224, stachel@physi.uni-heidelberg.de	Heavy Ion ALICE
Uwer, Ulrich, Prof. Dr.	Physikalisches Institut,	uwer@physi.uni-heidelberg.de	High Energy BABAR, LHCb
Fischer, Peter, Prof. Dr.	Schaltungstechnik und Simulation	+49-621-1812735 peter.fischer@ti.uni-mannheim.de	Informatic ATLAS, CBM
Männer, Reinhard, Prof. Dr.	Lehrstuhl für Informatik V	+49-621-1812642 maenner@ti.uni-mannheim.de	Informatic ATLAS, CBM
Eigen, Gerald, Prof. Dr.	Department of Physics Bergen	+47-555-82861 Gerald.Eigen@fi.uib.no	Particle Physics ATLAS, BABAR, ILC
Stugu, Bjarne, Prof. Dr.	Department of Physics Bergen	+47-555-82769 Bjarne.Stugu@fi.uib.no	Particle Physics BABAR, ATLAS
Nystrand, Joakim, Prof. Dr.	Department of Physics Bergen	Joakim.Nystrand@fi.uib.no	Nuclear Physics NA57, BRAHMS, ALICE
Ullaland, Kjetil, Prof. Dr.	Department of Physics Bergen	+47-555-82871 Kjetil.Ullaland@fi.uib.no	Microelectronics ALICE

Stadsnes, Johan, Prof.	Department of Physics Bergen	+47-555-82748 Johan.Stadsnes@fi.uib.no	Space Physics INTEGRAL, POLAR
Brønstad, Kjell, Prof.	Department of Physics Bergen	+47-555-82754 Kjell.Broenstad@fi.uib.no	Space Physics INTEGRAL, POLAR
Helstrup, Haavard, Prof. Dr.	Faculty of Engineering University College Bergen	+47-555-87561 Havard.Helstrup@hib.no	Technical Computing ALICE
Skaali, Bernhard, Prof. Dr.	Department of Physics University of Oslo	+47-228-56470 T.B.Skaali@fys.uio.no	Electronics ALICE
Svensson, Bengt Gunnar, Prof. Dr.	Department of Physics University of Oslo	+47-228-57467 B.G.Svensson@fys.uio.no	Electronics Microelectronics
Tveter, Trine, Prof. Dr.	Department of Physics University of Oslo	+47-228-56414 T.S.Tveter@fys.uio.no	Nuclear Physics NA57, BRAHMS, ALICE
Stapnes, Steinar, Prof. Dr.	Department of Physics University of Oslo	+47-228-55063 Steinar.Stapnes@fi.uio.no	Particle Physics ATLAS

KAPITEL 1. GENERAL INFORMATION

1.3 Report period

Four years starting 1. April 2004 - 31. March 2008 ???

1.4 Number of Stipends

position	method of financing	finance amount	number
doctorand	stipend (max)	1468,00 €	15
post-doctorand	position (TVL 13)	3752,59 €	2
doctorand	extern	–	4

1.5 Web page address

The web presentation of the IRTG can be found at:

<http://irtg.physi.uni-heidelberg.de>.

Chapter 2

Research Program

As described in the proposal the basic idea of the IRTG is to foster the interdisciplinary research combining the three building blocks

- fundamental physics in the field of elementary particle und nuclear physics,
- detector and computing technologies,
- running and analysis of experiments.

The basic goal has been reached by the creation of the ITRG. All the major areas are represented in the IRTG and an intensive exchange of ideas has been started. The weekly seminar and the bi-annual meetings offer the possibility to look into the activities of participating groups that normally would have escaped attention.

Table 1.2 shows the currently participating groups with their main activities and projects relevant to the IRTG.

The main research topics that were addressed in the German groups within the context of the IRTG as well as the links to other groups participating in the IRTG are described on a group by group basis below:

N. Herrmann

The group is involved in the development of high resolution time-of-flight counters, so called resistive plate chambers (RPC) that are used in particle and nuclear physics experiments for particle identification in the momentum range below 5 GeV/c. In the context of the IRTG a PhD student (E. Cordier) studied the feasibility of this concept as a part of the particle identification scheme of CBM, the new heavy ion experiment at FAIR. One of the key observables of CBM is the observation of charmed particles close to their production threshold. At the new FAIR facility baryonic densities of up to ten times normal nuclear matter densities are expected to be reached. The production yield and phase space distribution of charmed hadrons is

CHAPTER 2. RESEARCH PROGRAM

predicted to be sensitive to the phase structure and the properties of the surrounding strongly interacting matter. The experimental challenge is the measurement of very small cross sections requiring interaction rates of up to 100 MHz. This can only be dealt with by fast detectors and a data driven data acquisition concept. Within this activity the concept for the front-end electronics was extensively discussed with other experts participating in the IRTG (Stachel, Ullaland). The digitising scheme is scrutinized in co-working with the group of P. Fischer. Even the readout concept (with expert input from Kebschull, Lindenstruth, Männer) was elaborated, since it impacts on the physics performance. The Physics topics (strange and charmed meson identification) had a large overlap with the interest of the Roehrich's research and benefitted substantially.

Following the same research line a postdoc (A. Reischl) is how coordinating the CBM - TOF R&D effort, trying to make use of the expertise in the IRTG as much as possible. Currently the FOPI group, that represents the scientific environment for his research, operates an RPC - TOF barrel of 4600 timing channel with the world best resolution reported so far ($\sigma_{t\text{sys}} \leq .95ps$). Since so many groups are involved into CBM already, the IRTG represents an ideal place exchange conceptual ideas in an early phase and stimulate inputs from the young researchers.

P. Fischer, R. Männer

The groups from the University of Mannheim that are involved in the sensor and trigger development of the ATLAS and CBM experiments, although enthusiastically supporting the concept of the IRTG, did not embark on extending their connections within the IRTG. The main reason behind this limitation to teaching activities lies in the act that those groups support their students with full positions, a common practice in the field of technical informatics. Since this is incompatible with the DFG stipends (even the enhanced ones) no stipend could be given to these groups. Although their expertise fits fully to the profile of the IRTG, it was decided to discontinue their participation.

U. Kebschull

The research of this group focuses on two research topics: A novel compute cluster and detector management framework and technologies for digital signal processing of data gathered from physical experiments like ALICE or FAIR CBM.

Within the context of IRTG we investigated the influence of radiation to commodity digital components like DRAM and FPGA (Field Programmable Gate Arrays). A PhD student (Gerd Tröger) studied the behaviour of FPGAs in a radiation environment at the same energy and flux rate as expected in a detector like ALICE TPC or FAIR CBM. During beam experiments in Oslo we found, that the configuration memory of the FPGA itself is cor-

rupted by high energy particles, instead of the integrated flip-flops. This happens at relatively low particle energies.

We therefore investigated a novel configuration refresh technology based on dynamic partial reconfiguration, which repairs single event upsets in FPGA at runtime. Using the refresh technology, the runtime of an FPGA within a detector can be prolonged by a factor of 10 during an experiment. Beam tests in Oslo showed, that this technology works as expected and therefore, it was adopted to ALICE TPC Read-Out Controller (ROC) at a very late design stage: It lead to a redesign of the so far designed ROC, including a technology change from Altera to Xilinx FPGAs.

The work carried out was done in close cooperation with Röhricht and Lindenstruth. Due to the enormous impact in terms of runtime between two failures, these technologies will also be adopted for CBM read-out-controller (CBM ROC). The results showed that IRTG forms a perfect place for interdisciplinary cooperation between computer engineers and physicists. The international cooperation between different research groups is one of the major impact to current detector developments.

V. Lindenstruth

The research groups activities within the frame work of intelligent detectors centers around the ALICE TRD trigger and High Level Trigger. The TRD Trigger implements about 280000 RISC processors on 70000 microchips, mounted on the detector, being read out by 1080 optical fibers running at 2,5 GBits/sec. These fibers are fed into the global tracking unit GTU, where up to 80000 track segments are processed within about 1,2 microseconds, using high-end FPGAs. This device has been produced, installed and commissioned, requiring the development of high-speed data management algorithms, synchronizing the various data objects and processing them on-line. The GTU allows to inject data into the optical receivers, therefore implements the ideal mock-up data source and is being used as such. The various modules implement a linux system for maintenance. It has turned out that the handling of errors in the asynchronous trigger sequences is incomplete in ALICE and an appropriate test bench was developed, allowing to verify the graceful recovery from such errors. Two Ph.D. positions are currently active in this field (Cuveland, Rettig).

The second major activity centers around the ALICE High Level Trigger, which is a high performance compute farm, analysing the on-line data, being received from 400 optical fibers. In order to get the HLT to its operational state of today a large number of advancements had to be done. On one hand the FPGA coprocessors, the HLT RORCs had to be produced, finalized and commissioned, the entire farm itself had to be installed with all the infrastructure computing. On-line monitoring, event selection and display infrastructure was developed, allowing to sample any event and display it using the ALICE visualization infrastructure ALIEve. Significant effort

CHAPTER 2. RESEARCH PROGRAM

was the development of the infrastructure, making the compute farm highly reliable. Two Ph.D. positions are currently active here (Thder, Alt). The main cooperation partners are Kebschull, Rhrich, Skaali. The IRTG provided an invaluable frame work for the close collaboration and cooperation on these complex projects. The students have organized themselves and formed task forces in order to tackle the many problems, which arose during the project. For instance the cluster finder in the HLT cannot be fully debugged and operated without close collaboration with the computer and the detector experts, which was easily possible in the frame work of the IRTG. In particular the PHOS detector was commissioned using the HLT.

H.C. Schultz-Coulon, K. Meier

The IRTG group at the Heidelberg Kirchhoff-Institut fr Physik is a member of the ATLAS Collaboration at the CERN Large Hadron Collider (LHC). The LHC and ATLAS as a general-purpose detector in particular will provide unprecedented insights into the physics at the Terascale. Terascale physics is expected to include the mechanism of electroweak symmetry breaking and possibly a solution for the eminent hierarchy problem of the standard model. Recent advances in theoretical physics have provided well-founded proposals to include gravity into the microscopic theory of matter. This approach allows for spectacular signatures arising from extra spatial dimensions or mini-black holes at LHC energies.

The hadronic initial state in pp-collisions at the LHC poses an enormous challenge to detector technology. The detectors need to be equipped with sophisticated data selection mechanisms in order to secure the rare events from new physics in a heap of QCD induced backgrounds of little physics interest. The Heidelberg KIP group has taken over the responsibility to design, build and operate the Calorimeter Trigger Preprozessor (PPr) of ATLAS. The PPr fills 8 large crates with state-of-the-art technology including about 18.000 application specific chips mounted on 2000 multi-chip-modules. The system is now installed and fully operational. The PPr has evolved on the fertile grounds provided by the technology related infrastructure in the IRTG environment. IRTG students (Frederik Rhr and Victor Andrei) have played a major role in the project. Their constant scientific exchange with students and scientists involved e.g. in the ALICE, H1 and LHCb projects has been instrumental. Other local structures like the Heidelberg ASIC Laboratory, the new HGF Terascale Alliance and the Heidelberg Graduate School of Fundamental Physics synergise well with the complementary concept of the International Graduate School on Intelligent Detectors.

In addition, the IRTG group at the Heidelberg KIP was involved in the H1-experiment at the ep-collider HERA (DESY, Hamburg), in particular in the commissioning, the optimization and the operation of the H1 Fast Track Trigger (FTT). The FTT was designed in the framework of the HERA upgrade programme as a three-level trigger system for fast pre-selection of

track-based signatures. This is of particular interest for the analysis of heavy quark production in ep-collisions and the extraction of the gluon content of the proton. The functionality of the FTT is based on modern FPGA-technology allowing fast and efficient track finding within microseconds. On the second trigger level a 3-dimensional track fit is done using DSPs. These tracks are then sent to a PowerPC Processor farm (FTT level-3) used to calculate invariant masses for the identification of meson resonance decays; this is done within a latency of 100 ns, even if track-multiplicities are large. Due to the Fast Track Trigger the amount of recorded ep-events with an identified D^* -meson, i.e. with a tagged charm quark, could be increased by about a factor of ten. With this new wealth of data a precise extraction of the proton gluon-density should now be possible. This success is based to a great extent on the work of the IRTG student A. Jung who has played a central role in the FTT project and significantly profited from the funding and the environment provided by the International Graduate School on Intelligent Detectors. Moreover, his experience gained at a running high-energy experiment was important input to the scientific discussions among IRTG students, most of them being involved in preparing the LHC experiments.

J. Stachel This group is involved in the context of the IRTG in three activities. The CERES experiment was extended by the addition of a radial TPC, the first of its kind, and data from the run in 2000 with 158 A GeV/c Pb + Au collisions are being analyzed. Largely the data analysis is completed. But a new type of analysis is the subject of the ongoing doctoral thesis of IRTG doctoral student R. Soualah: Here photon conversions in the RICH mirror directly upstream of the TPC and subsequent analysis of two electron-positron pairs under very small angles are used to reconstruct π^0 mesons. This project lead also to a feasibility study for ALICE, where again the main tracking detector in the central barrel is a TPC. Here not only the analysis of π^0 and η distributions but also also direct photon physics, a jet trigger, and a possibility to obtain a high statistics sample of identified electrons as reference distributions for the particle identification with the TRD are the focus. The results are very encouraging. The jet trigger is a joint interest with the group of V. Lindenstruth and has also close ties to the ALICE High Level Trigger where D. Roehrich is involved. The main focus of the group have been in the past few years the construction, integration, and commissioning of the ALICE TRD. This novel transition radiation detector enhances the electron identification capabilities of the ALICE central barrel with pion suppression of better than a factor 100 and provides a fast trigger on electrons, electron pairs, and jets within 6.5 μ s. There is close collaboration with the group of V. Lindenstruth. IRTG doctoral student D. Emschermann was closely tied into the integration and installation of the TRD as well as performance tests with testbeams at the CERN PS. The expertise gained from the electronics development for the

CHAPTER 2. RESEARCH PROGRAM

ALICE TPC and TRD is currently applied to develop a generic front-end chip that can be used for several of the detectors in the CBM experiment. This is carried out in cooperation with the development of the RPC TOF detector by N. Herrmann and also involves collaboration with the group of K. Ullaland.

U. Uwer

The group is participating in two high-energy physics experiments; in the LHCb experiment currently being commissioned for the start of LHC, and in the BABAR experiment at Stanford (SLAC) which completes data-taking at the beginning of April. Both experiments are in a very different phase. Together they offered in the last years the full spectrum of experimental particle physics: from detector development and construction, over detector calibration and understanding to data-analysis.

The Heidelberg LHCb group has developed and built major parts of the readout electronics of the LHCb Outer Tracker detector. The most important component built and produced in Heidelberg is a 32-channels ASIC to measure and digitize the drift-times of the tracking detector. J. Knopf, a IRTG funded doctoral student, has assembled, commissioned and operated the first complete readout-chain. His setup was used during beam-tests and served in modified form also as basis for many test-setups. In his project, Jan Knopf profited considerably from the expertise on digital electronics and on the usage of FPGAs which emerged in the context of the Graduate School (group of V.Lindenstruth). Meanwhile most of the electronics is installed and already commissioned. The group activities now have shifted towards the detector system operation. C. Langenbruch, another IRTG funded doctoral student is responsible for developing the control and monitoring software of the Outer Tracker system.

The BABAR participation of the group does not include detector any hardware project. Instead, the group is working on a refinement of the calibration algorithms for the BABAR calorimeter and on pre-shower detection exploiting existing information from the BABAR Cherenkov detector. The latter is the project of A.Adametz, who in addition works on the measurement tau-lepton branching fractions.

2.1 List of stipends

The members of the ITRG are listed in the following table. Note that the maximum period for direct support through the ITRG was limited to strictly 3 year. Several PhD students were not able to complete their thesis within the standard period of 3 year mainly due to severe delays on the LHC completion. Those people are kept as external members of the IRTG and are still participating in all the program (seminars and lecture weeks).

2.1. LIST OF STIPENDS

Table 2.1: Content of table members

Name	Title of dissertation	Supervisors	First degree date / place	Funding period	Date of phd	Grade	Occupation	report
Aleksandra Adametz	Messung hadronischer Tau-Zerfälle mit Netto-Strangeness zur Bestimmung des CKM Matrixelements VUS	U. Uwer		2007-01-01 2008-12-31	2008-12-31	-	IRTG	2.2.1
Torsten Alt	HLT FPGA Co-Prozessoren	V. Lindenstruth		2004-10-15 2007-10-14	2008-10-15	-	TVL13	2.2.2
George V. Andrei	Optimierung des ATLAS Level-1 Kalorimeter Trigger fuer den Nachweis von Ereignissen mit fehlendem Tr	K. Meier		2005-03-01 2008-02-29	2008-09-30	-	IRTG	2.2.3
Oliver Brosch	Algorithmen fuer die Datenauslese bei CBM	R. Männer		2004-12-01 2005-05-31				-

CHAPTER 2. RESEARCH PROGRAM

Barbara Böhmer	Entwicklung eines schnellen, ortsaufweisenden, grossflächigen Roentgendetektors	N. Herrmann	2005-01-01				2.2.4
Everard Cordier	fopi	N. Herrmann	2005-04-01 2007-07-31				–
Jan de Cuveland	Entwicklung der ALICE TRD Global Tracking Unit	V. Lindenstruth	2004-10-15 2007-10-14				2.2.5
David Emsermann	Inbetriebnahme einer ALICE TRD-Kammer mit voller Elektronik und Trigger bei Teststrahl und Evaluierung	J. Stachel	2004-11-01 2007-10-31				2.2.6
Wenxue Gao	Development of an active buffer for the CBM experiment	R. Männer	2005-01-01 2005-09-30				–
Sergey Gorbunov	Fast Kalman Filter	V. Lindenstruth	2007-11-01 2008-10-31				–
Marcus Gutfleisch	Local Signal Processing of the ALICE TRD at LHC CERN	V. Lindenstruth	2005-08-01 2006-01-31				–

2.1. LIST OF STIPENDS

Hafermann	ASIC-Detektor fuer Metastabile Atome	N. Herrmann	2004-12-01 2005-06-30						–
Michael Henke			2008-01-01 2008-12-31						–
Andreas Jung	Optimierung, Aufbau und Einsatz des schnellen Spurtriggers von HI	H-C. Coulon	2004-10-15 2007-10-14						2.2.7
Jan Knopf	Assembly and testing of the Outer Tracker DAQ System at CERN	U. Uwer	2004-12-01 2007-11-30						2.2.8
Christoph Langenbruch	LHCb	U. Uwer	2007-12-01 2008-30-11						–
Felix Rettig	Entwicklung der ot. Auslekette fuer den ALICE-Übergangsstrahlungsdetektor am LHC	V. Lindenstruth	2007-07-01 2009-03-30						2.2.10
Frederik Rühr	Untersuchung und Optimierung des ATLAS-Triggers zum Nachweis neuer Phaenomene	K. Meier	2005-01-01 2007-12-31						2.2.11

CHAPTER 2. RESEARCH PROGRAM

Schenk	Messung des Martix-Elements VUS mittels hadronischer Tau-Zerfälle mit BABAR Detektors	U. Uwer	2005-01-01 2005-03-31						–
Rachik Soualah	Reconstruction of neutral pions in the CERES/NA45 experiment	J. Stachel	2005-10-01 2007-09-30						2.2.12
Jochen Thäder	ALICE HLT Commissioning and Jet Trigger	V. Lindenschtruth	2007-01-01 2007-12-31						2.2.13
Gerd Tröger	Verbesserung der Strahlfestigkeit von FPGAs durch partielle Rekonfiguration zur Laufzeit	U. Kobschull	2005-04-01 2008-03-31						2.2.14
Postdoctoral researchers funded by the DFG									
Name	Project/ topic	Doctorate date / place	Funding period	Individual tasks IRTG related	Current employment	report			
Markus Mer-schmeier	FOPI; CBM	?	2005-10-01 2007-03-31		University Münster	–			

2.1. LIST OF STIPENDS

Andreas Reischl	FOPI; CBM	2007-04-03 Amsterdam	2007-07-15 2009-03-31		IRTG	2.2.9
--------------------	-----------	-------------------------	--------------------------	--	------	-------

CHAPTER 2. RESEARCH PROGRAM

2.2. REPORTS OF THE STIPENDIARIES

2.2 Reports of the stipendiaries

2.2.1 Report by stipendiary Aleksandra Adametz

Subject	Measurement of τ -lepton Decays to Hadronic Final States with Net-Strangeness
Supervisor	Prof. Dr. U. Uwer
Status	ongoing
Duration	1-5-2005 until 31-12-2008
Start in Grako	1-1-2007
Age start	27 years

Description of the PhD project and achieved research results

The goal of the study is a contribution to a measurement of the Cabibbo-Kobayashi-Maskawa (CKM) matrix element V_{us} which is accomplished by the BaBar group of Prof. Dr. U. Uwer in Heidelberg.

The Babar experiment [282] is located at the PEP-II e^+e^- collider of the Stanford Linear Accelerator Center (SLAC) in California. The exploratory focus [283] of the experiment is the investigation of the CP-violation and the measurement of the CKM-matrix parameters. Physics analyses mainly study the decay properties of B-mesons which are produced in pairs with a cross section of about 1 nb in e^+e^- -interactions at a center-of-mass energy of 10.58 GeV.

Besides B-physics BaBar offers an excellent possibility to study τ -leptons. The high production cross section of almost 1 nb and the integrated luminosity of about 390 fb^{-1} result in an dataset of almost 400 Mio. τ -lepton pairs.

This large dataset can be used for an alternative determination of V_{us} . The current world average of V_{us} ($|V_{us}| = 0.2257 \pm 0.0021$ [284]) is based on a measurement in kaon decays. The error is dominated by the theoretical uncertainty of the kaon form factor. The study of τ decays allows an independent approach to V_{us} .

For this the total hadronic decay rate

$$R_\tau = \frac{\Gamma(\tau \rightarrow H\nu_\tau)}{\Gamma(\tau \rightarrow e-\bar{\nu}_e\nu_\tau)} \quad \text{with } H = \text{hadrons}$$

is considered which can be splitted in $R_{\tau(u,d)}$ and $R_{\tau(s)}$. Where $R_{\tau(u,d)}$ is the τ -lepton decay rate of decays with final states without strange quarks and $R_{\tau(s)}$ is the decay rate with “net-strangeness” (final state with the quantum number strangeness $S = -1$ or $S = 1$).

The difference $\delta R(m_s)$

$$\delta R(m_s) = \frac{R_{\tau(u,d)}}{|V_{ud}|^2} - \frac{R_{\tau(s)}}{|V_{us}|^2}$$

CHAPTER 2. RESEARCH PROGRAM

which can be calculated in theory and which depends on the value of the strange quark mass allows to determine V_{us} by measuring the hadronic τ -lepton decay rate $R_{\tau(s)}$ [285]. $R_{\tau(n,s)}$ and $|V_{ud}|$ are taken from other measurements.

The goal of the thesis is the measurement of all remaining decay channels and the consistent treatment of all channels already measured by the Heidelberg group.

The focus of my current work is the measurement of the branching fraction of the decay $\tau^- \rightarrow K^- \eta \nu_\tau$ (BR=(0.0027 ± 0.006)% [284]). The η -meson is reconstructed in the channel $\eta \rightarrow \gamma\gamma$ (BR=(39.43 ± 0.26)% [284]). The measurement of this τ -lepton decay with a relatively small branching fraction suffers from large backgrounds from other τ -lepton decays with η -mesons and π^0 -mesons in the final state (e.g. $\tau^- \rightarrow K^- \pi^0 \nu_\tau$). The suppression of these backgrounds is one of the main challenges of this measurement. The selection of $\tau^- \rightarrow K^- \eta \nu_\tau$ events is already finalized. Figure 2.1 shows the distribution of the invariant η mass after event selection.

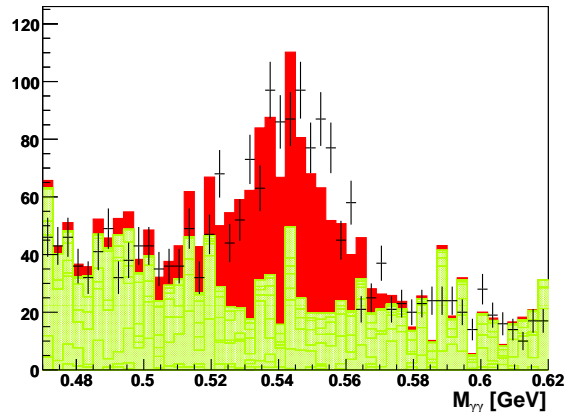

Figure 2.1: Invariant η mass after event selection. Data (black points), $\tau^- \rightarrow K^- \eta \nu_\tau$ simulation (red), simulated background (green). The dominant contributions to the background are τ -lepton decays in hadronic final states with π^0 -mesons.

Further important steps which will be done within this analysis are the determination of the η identification efficiency which was not measured until now by BaBar and the study of systematic uncertainties.

As a PhD student using data from the BaBar experiment I also have to contribute to the running of the detector. My BaBar Service Task is a feasibility study and the implementation of a software algorithm for the identification of so called “Preshowers”. “Preshowers” are photons which started an electromagnetic shower already in front of the BaBar calorimeter

2.2. REPORTS OF THE STIPENDIARIES

due to interactions with material of the inner detector components. These electromagnetic showers lose a fraction of their energy already in front of the calorimeter which leads to a degradation of the measured energy resolution in the calorimeter. The feasibility study showed that it is possible to identify “Preshowers”. The developed software algorithm was included into a Babar software release which will be used for the re-processing of the entire dataset collected by BaBar. Thus the results of this study are made available to the whole BaBar collaboration.

Cooperation with respect to other projects

Cooperation with SLAC (CA, USA).

Attendance at the study program

11-15 April 2007, Bergen (Norway), IRTG school of ‘Data Acquisition and Trigger Systems’ in the frame of the Grako.

Supervision in the IRTG

The participation in the Grako offers a great possibility to widen physical knowledge as well as to improve further skills important for scientific work. The interesting regular seminars provide instructive insight into the work of other PHD students and allow an exchange of experience. The discussions and presentations of general physics subjects give an opportunity to deepen the understanding of a broader range of topics and to improve presentation skills by giving talks oneself.

The biannual IRTG schools address current and interesting topics and allow to meet international colleagues.

Stays abroad

20 April - 8 May 2007, SLAC, Palo Alto (CA, USA), Detector shifts
03 July - 01 August 2007, SLAC, Palo Alto (CA, USA), Work on the
“Preshower” identification project
25-27 September 2007, Paris, (France) - BaBar Collaboration Meeting

Presentations

Several status presentations in SLAC group meetings and collaboration meetings in person or via conference calls.

CHAPTER 2. RESEARCH PROGRAM

2.2.2 Report by stipendiary Torsten Alt

Subject	ALICE HLT FPGA based Read-Out and Pre-processing PCI Card
Supervisor	Prof. Dr. V. Lindenstruth
Status	ongoing
Duration	15-10-2004 until 15-10-2007
Age start	29 years
employment situation	Wissenschaftlicher Angestellter

Description of the PhD project and achieved research results

The ALICE High-Level-Trigger(HLT) is a multi-node, multi-processor computing farm dedicated to receive raw data from various detectors and make trigger decisions based on an online analysis of the data. Before processing raw data it needs to be received and transferred to the main memory of the HLT computing farm. The Ph.D. thesis covers the development of a FPGA based PCI-X card called H-RORC (ReadOut and Receiver Card) and the design of a framework in hardware to receive, replay and preprocess simulated or raw data.

The H-RORC is based on an Field Programmable Gate Array (FPGA), a logic device which can be programmed with a digital design to fulfill special tasks. First task is to receive raw data coming from the detector via optical links called Detector Data Links (DDLs). Each DDL can transmit 200 MByte/s and the H-RORC supports two of this links thus giving a maximum input rate of 400 MByte/s for one RORC. Once the data is received it is handled by a framework which allows two options. The first option is to transfer the data directly into the main memory of the HLT nodes to allow further processing and analysis in software. The second option is to preprocess data directly inside the hardware framework and then transfer it to the main memory. Preprocessing modules can be plugged into the framework to allow different detector groups to design their own module for detector specific tasks. During the Ph.D. thesis a module for the TPC called Clusterfinder was developed which is the first step in the chain of trackfinding. Particles crossing the TPC will leave a trace of primary ionized atoms. These atoms drift towards the endcaps of the TPC where they are amplified and generate a charge cloud of secondary ionized atoms. In order to reconstruct the track the center of gravity of this charge cloud needs to be calculated. This can either be done in hardware or in software and since the HLT has a limited time budget for the online analysis this is done in hardware on the fly. More than 200 H-RORCs were produced, tested, commissioned and installed in the HLT farm allowing to receive up to 40 GByte/s of raw data from the detectors.

2.2. REPORTS OF THE STIPENDIARIES



Figure 2.2: HLT-ReadOut-Receiver-Card

Attendance at the study program

The following schools were attended:

IRTG Spring School 2005, Bergen : Advanced Instrumentation for future accelerator experiments

IRTG Fall School 2005, Heidelberg : Programmable hardware and hardware programming

IRTG Spring School 2006, Oslo : Introduction to high energy and nuclear physics

IRTG Fall School 2006, Heidelberg : Frontiers of particle identification

IRTG Spring School 2007, Bergen : Data acquisition and trigger systems

Supervision in the IRTG

The IRTG not only takes care of the financing of the participants, it also covers other aspects which are crucial for a good scientific education. Seminars and discussions on a weekly base, where either external speakers or participants of the IRTG give an overview of their current research, give an insight into actual physical or technical questions and show ideas and methods to get answers. In addition to the weekly seminar two IRTG schools every year with lectures and hands-on workshops cover various topics from high energy and nuclear physics to detector development and hardware/software design. Taking place in Norway and Germany with people from different countries they provide the chances of working in an international team and cultural exchange.

Stays abroad

During my research I stayed two times in Cagliari, Italy, for integration of the H-RORC into the ALICE DiMuon HLT and several times at CERN,

CHAPTER 2. RESEARCH PROGRAM

Switzerland, for installation, integration and testing of the H-RORC in the HLT computing farm.

Publications

Several talks in the IRTG seminar and 3 talks for the meetings of the Deutsch Physikalische Gesellschaft (DPG).

2.2.3 Report by stipendiary George V. Andrei

Subject	”Optimierung der ATLAS Level-1 Kalorimeter Trigger für den Nachweis von Ereignissen mit fehlendem Transversalimpuls”
Supervisor	Prof. Dr. Karlheinz Meier
Status	ongoing
Duration	01-03-2005 until 31-12-2008
Age at start	29 years

Description of the PhD project and achieved research results

My work for the ATLAS project has referred to the optimization and integration of the PreProcessor System of the ATLAS Level-1 Calorimeter Trigger. The actual work has implied development of software and hardware tools to test, install, commission and monitor the PreProcessor System. Thoroughly testing the operation of the system before to install it in the electronics cavern of the experiment is a mandatory task. Then, commissioning and monitoring tools are required to continuously check the correct operation of the system in-situ, both as an individual entity as well as an integrated part in the calorimeter trigger system.

The ATLAS Level-1 Trigger is the first stage of event selection for the ATLAS experiment. It is designed to provide a trigger decision in less than 2.5 μ s in order to reduce the LHC bunch-crossing rate of 40 MHz down to a rate of 75 kHz, based only on calorimeter and muon detector data. It consist of a Muon Trigger and a Calorimeter Trigger to process data from the two subdetectors, and a Central Trigger Processor, the logical unit of the Level-1 Trigger, which combines information from the two trigger units to reach an overall L1-Accept decision (see figure 2.3a).

The calorimeter trigger information consists of about 7200 analogue signals from the entire ATLAS Calorimetry. The signals are transported over up to 70 m long cables from the front-end electronics of the calorimeters (situated in the experimental cavern) to the input of the calorimeter trigger (located in the electronics cavern), via a Receiver System of which its main role is to weight the analogue signals in order to convert the energy to transverse energy.

The Level-1 Calorimeter Trigger (L1Calo) is a highly parallel system with fast algorithms implemented in Application Specific Integrated Circuits (ASICs)

2.2. REPORTS OF THE STIPENDIARIES

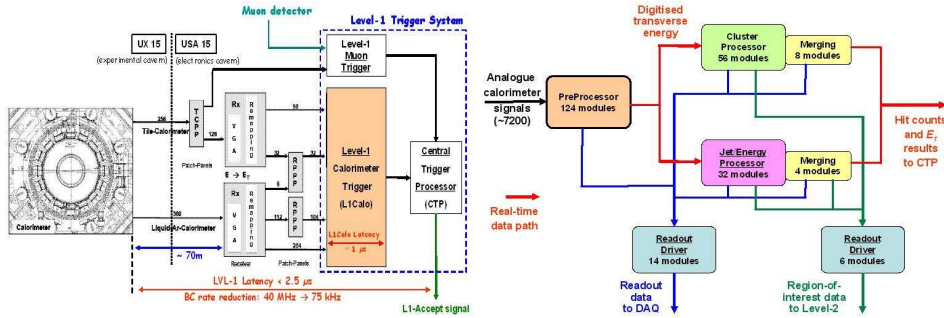

Figure 2.3: Overviews: ATLAS Level-1 Trigger (a) and ATLAS Level-1 Calorimeter Trigger (b).

and Field Programmable Gate Arrays (FPGAs), of which the real-time data path consists of three subsystems: PreProcessor (PPr), Cluster Processor (CP) and Jet/Energy-Sum Processor (JEP). The PPr System is a highly modular and compact system to receive and process in parallel the 7200 analogue calorimeter trigger signals. The processing results, meaning digital values of E_T , form the basis of the digital trigger decision, and they are transmitted downstream to the CP and JEP, which identify and count *small* and *large objects* as well as compute the global energy sums (see figure 2.3b).

The main component of the PPr System is the PreProcessor Module (PPM). The complete system consists of 124 hardware identical 9U VME PPMs which fit into 8 crates. Each module receives and processes in parallel 64 analogue calorimeter trigger signals. The main signal processing is being performed in custom-built ASICs, which were developed in the ASIC Laboratory of the University of Heidelberg: synchronisation of pulses originating from the same event to the same bunch-crossing clock tick; bunch-crossing identification of the E_T deposition per trigger channel and of the corresponding bunch-crossing, for pulses both in the linear range and the saturated region; noise suppression, pedestal subtraction and fine-calibration of extracted E_T using a look-up table. The digital results of processing are then serialised and sent as LVDS data streams at a rate of 480 Mbit/s to the *object-finding* processors of the calorimeter trigger.

Additionally, the module provides a bidirectional VME interface to the crate controller CPU in order set control data, download firmware on the board or to perform debugging and local monitoring of the system, and a DAQ interface to document the trigger decision. Also, a Slow Control interface to control and monitor the crate infrastructure via a CAN-bus system is provided (see figures 2.4a and 2.4b).

Until the end of October 2006 my work mainly focussed on the monitoring of the PPr System. During that phase of the project integration tests performed at CERN to check the connectivity of the analogue cables from

CHAPTER 2. RESEARCH PROGRAM

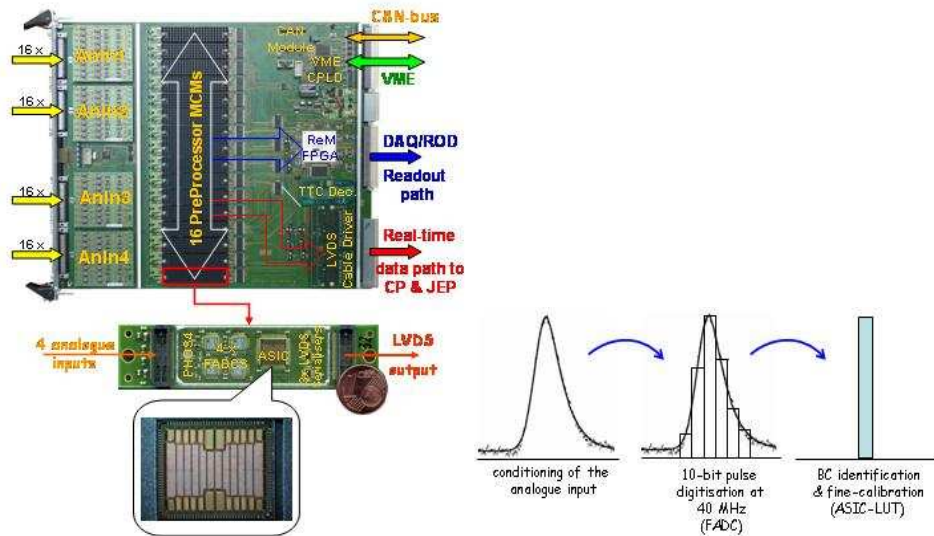

Figure 2.4: The PreProcessor Module: the hardware realisation (a) and the processing of the input analogue calorimeter trigger signals performed on the module (b).

the front-end electronics of the Tile Calorimeters to the input of the PPr System, as well as to check the quality of the analogue signals after a transmission over up to 70 m long cables. My contribution to these tests mainly implied the development of a monitoring package, integrated in the L1Calo Online Software, to decode the readout data stream and provide histograms of certain quantities specific to each test, e.g. readout statistics for each PPM channel, pedestal estimation per channel, signal amplitudes or rise time and full-width at half maximum of the signals (see figure 2.5).

Additionally, I contributed to the development of the *L1Calo Online Software* with a *mapping* tool which translates the hardware IDs of the PPr System, i.e., crate, module and channel IDs, into detector coordinates, i.e. pseudo-rapidity (η) and azimuthal angle (ϕ). The operation is needed in order to assign each trigger tower related quantity with the corresponding detector. Starting with November 2006 my work on the ATLAS project has been extended to the testing of the PPMs and their installation at CERN, in the electronics cavern of the experiment. For that I have built a test set-up in the ATLAS Laboratory of the Kirchhoff-Institut für Physik and developed an extensive test procedure to verify all functions of each PPM. I have developed automated tools to test the modules, both individually as well as in a crate configuration similar to that of the final system. Additionally, I developed and built a test board, integrated into a dedicated VME system, in order to check by both software and hardware means the LVDS real-time output of the PPMs after a transmission over 15 m long LVDS cables (the

2.2. REPORTS OF THE STIPENDIARIES

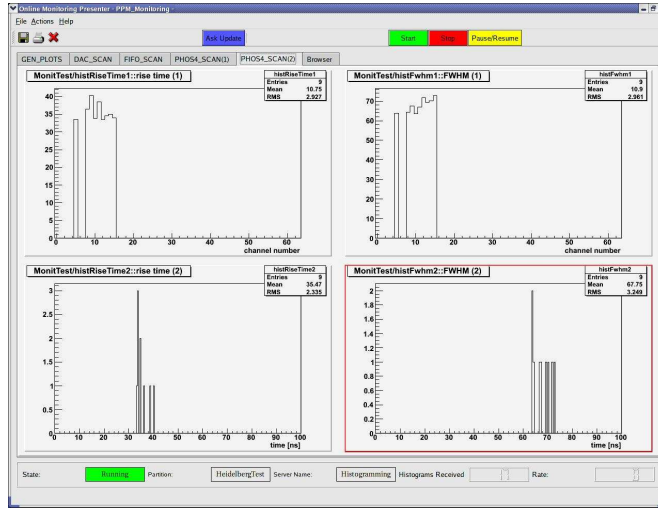

Figure 2.5: Example of monitoring done during initial signal quality tests. The *upper* histograms describe the rise time and the FWHM values of the calorimeter signals as determined for in each channel of one PPM. The *lower* histograms describe the same values as projected on the y-axis.

length of the LVDS cables in the configuration of the final system is 11 m). And last but not least, I have developed a monitoring application to verify the operating conditions of the modules (e.g. domains of temperature, voltages across the board), a tool which is also used periodically at CERN (see figure 2.6a).

Once the modules pass the functional tests, they are send to CERN for installation. During the summer and autumn of 2007 I have traveled several times to CERN to help with the installation of the PPr System (see figure 2.6b). At the time this report is written the last out of 124 modules required by the full-coverage of the experiment are being installed at CERN.

In paralell to the hardware work, I have continued the work on the monitoring the PPr System. Starting with July 2007 the Level-1 Calorimeter Trigger has been integrated with other subdetectors into dedicated ATLAS combined runs and into regular cosmic ray runs. My contribution to these runs has included the development of applications, running either as standalone applications on the crate controller CPU or integrated in the Online Software, to monitor the physical and operational aspects of the PPr System and the performance of the trigger, using event data sampled at various points along the pre-processing chain. Histograms of certain hardware and physics quantities, e.g. temperature maps, readout statistics, plots of energy depositions per trigger cell or hit maps, are built during the runs and made available to the shift crew in the Control Room of the ATLAS experiment.

CHAPTER 2. RESEARCH PROGRAM



Figure 2.6: The full-crate test set-up built in the ATLAS Lab@KIP to test the PPMs (a) and details of the installation of the PPr System at CERN, in the electronics cavern of the experiment - as of August 2007 (b).

Cooperation with respect to other projects

Though there is no direct cooperation between my project and the other groups participating in the IRTG, the regular seminars offered the possibility of a good insight into the status and perspectives of each project. Also, the diversity of presentations given within the same program furnished a substantial background with respect to the trigger, data acquisition and data analysis techniques used in the high energy physics experiments.

Attendance at the study program

I have attended twice the schools organized by the International Research Training Group (IRTG):

- *Heidelberger VHDL Graduate Courses*, Fall School, September 2005, Heidelberg
- *Introduction to high energy particle and nuclear physics*, Spring School, March 2006, Oslo

Also, I have attended several courses given during different editions of the *Heidelberg Physics Graduate Days*: 2005, 2006 and 2007.

Supervision in the IRTG

Throughout my research work I have benefited from professional feedback

2.2. REPORTS OF THE STIPENDIARIES

and suggestions, provided by the various academic members of the University Heidelberg actively involved in the IRTG program. Their permanent support motivated me and helped me further develop as a researcher.

Stays abroad

My doctorate studies have so far not implied a long stay abroad. However, as a member of the International Research Training Group (IRTG) I was offered the possibility to constantly travel abroad in order to attend different conferences, workshops or collaboration meetings which were extremely useful for my work.

Conference Contributions, Talks and Publications

Talks held on conferences like e.g. Electronics for LHC, TWEPP-07 Topical Workshop on Electronics for Particle Physics, the DPG spring meeting 2007/8 and within the *ATLAS Level-1 Calorimeter Trigger* Joint Meetings. [319]

2.2.4 Report by stipendiary Barbara Böhm

Status	finished 2/2007
Supervisor	N. Herrmann
Duration	01-01-2004 until 31-12-2006
Age start	26 years
after	first postdoc; now industry

Description of the PhD project and achieved research results

Im Jahr 1901 wurde der erste Nobelpreis der Physik an Wilhelm Conrad Röntgen für seine Entdeckung der Röntgenstrahlen vergeben. Schon damals betonte das Nobelpreiskomitee neben der rein wissenschaftlichen auch die große praktische Bedeutung dieser Strahlen. Da die heutige Grundlagenforschung in nahezu allen Bereichen ohne Röntgenstrahlung nicht mehr vorstellbar ist hat die Anzahl an Synchrotron-Forschungseinrichtungen in den letzten Jahren stetig zugenommen. Hier finden beispielsweise Untersuchungen von Werkstoffen und biologischen Substanzen durch Streuexperimente statt. Auch im medizinischen Bereich wurden durch den Einsatz von Röntgenstrahlung sowohl zur Diagnose als auch zur Therapie große Fortschritte erreicht. In allen Bereichen hat der Nachweis der Strahlung oft einen entscheidenden Einfluss auf die Qualität des Ergebnisses und führt somit zu sehr hohen Anforderungen an die Röntgenbildgebung.

Speziell im medizinischen Bereich geht die Forschung dahin, dass bei immer geringerer Dosis immer bessere Abbildungsergebnisse erzielt werden müssen. Hierbei kommt es nicht alleine auf eine sehr gute Ortsauflösung an, die es ermöglicht auch kleinste Details zu erkennen. Auch eine große Dynamik

CHAPTER 2. RESEARCH PROGRAM

sowie hohe Effizienz sind erstrebenswert, um einen guten Kontrast zu erreichen und damit die Strahlenbelastung eines Patienten gering zu halten. Jedoch ist es im Allgemeinen nicht möglich ein System zu entwickeln, das in allen wichtigen, den Detektor charakterisierenden, Parametern gleichzeitig das Optimum erreicht. Vielmehr bedingen sich die einzelnen Parameter oft in physikalischer und technischer Hinsicht und limitieren sich dadurch gegenseitig.

Da die heute immer noch üblichen analogen Technologien, die auf dem Prinzip der Photoplatte basieren, die hohen Anforderungen an Effizienz und Dynamik nur unzureichend erfüllen, wird an neuen digitalen Systemen geforscht.

In der Neutronenphysik-Arbeitsgruppe des Physikalischen Instituts wurde in den letzten Jahren ein Detektorkonzept entwickelt, das zunächst nur zum Nachweis von Neutronen gedacht war. Dieses CASCADE-Detektorkonzept entkoppelt erstmals eine Reihe wichtiger Parameter, wie Effizienz, Hochraten-tauglichkeit und Dynamik, Ortsauflösung sowie eine einfache technische Realisierbarkeit voneinander. Dadurch ist nun eine individuelle Optimierung für die jeweils angestrebte Applikation möglich.

Im Rahmen dieser Arbeit wurde untersucht, ob sich dieses Konzept mit seinen Vorteilen auf den Nachweis von Röntgenstrahlung übertragen lässt. Bei dem hier untersuchten CASCADE-Detektorprinzip handelt es sich um einen Vertreter der Gasdetektoren, der sich jedoch in einem wesentlichen Punkt von den üblichen Vertretern unterscheidet. Im Allgemeinen erfüllt das Gas in Gasdetektoren zwei Aufgaben gleichzeitig: Es ist Konvertermaterial und Zählgas. Hiervon unterscheidet sich das Prinzip des CASCADE-Detektors, in dem ein festes Konvertermaterial und ein Zählgas voneinander entkoppelt eingesetzt werden. Der Vorteil des Festkörpers liegt in der deutlich höheren Dichte der Konverteratome verglichen mit einem Gas und erlaubt somit einen Betrieb bei Normaldruck, was eine erhebliche technische Erleichterung bedeutet. Bei diesem neuen Detektorkonzept werden zur Erhöhung der Effizienz nun erstmalig mehrere feste Konverterschichten hintereinander angeordnet. Die Ladungstransparenz wird durch den Einsatz sogenannter Gas Electron Multiplier (GEM) Folien (entwickelt am CERN durch Sauli) als Trägermaterial für die festen Schichten ermöglicht. Diese stellen aufgrund ihrer perforierten Struktur ein ladungstransparentes Substrat dar, das auch den Erhalt der Ortsauflösung gewährleistet. Da es sich hier um einen zählenden Detektor handelt weist er eine große Dynamik auf. Damit sind beim CASCADE-Prinzip die den Detektor charakterisierenden Größen voneinander entkoppelt und eine Verbindung verschiedener Vorteile wie hohe Effizienz, gute Ortsauflösung und große Dynamik ist prinzipiell möglich.

Eine der Kernfragen, die sich im Rahmen dieser Arbeit stellte, bestand in der Analyse eines geeigneten Konvertermaterials. Im speziellen war eine Untersuchung der erreichbaren Effizienz erforderlich. Hierzu wurde ein mathe-

2.2. REPORTS OF THE STIPENDIARIES

matisches Modell entwickelt, das alle primären Prozesse, angefangen von der Konversion des Photons bis hin zum Nachweis des Photoelektrons, erfasst. Basierend auf dieser Grundlage wurden verschiedene Konvertermaterialien auf ihre Effizienz hin untersucht und die Ergebnisse miteinander verglichen. Nachdem auf Grundlage dieser Berechnungen einige Konvertermaterialien hinsichtlich der Effizienz ausgewählt wurden, musste die technische Realisierung untersucht werden. Hierbei geht es sowohl um den Prozess des Aufbringens der Materialien auf das Substrat (GEM-Folie), als auch um die Stabilität dieser Schichten. Die in dieser Arbeit verwendeten Schichten wurden durch Bedampfen und Sputtern hergestellt.

Auf den mathematischen Ergebnissen beruhend wurde ein Detektor zum Nachweis von Röntgenstrahlung aufgebaut, um die Berechnungen zu verifizieren. Für die Durchführung von aussagekräftigen Messungen wurden, neben unterschiedlichen Modifikationen des Detektors, geeignete monoenergetische Röntgenquellen benötigt, deren Aktivität genau bekannt ist. Zur Überprüfung der vom Hersteller angegebenen Daten wurden einige Messungen mit einem Germaniumdetektor des MPI für Kernphysik in Heidelberg durchgeführt. Die aus diesen Messungen resultierenden Ergebnisse machten einige Modifikationen an den Präparaten erforderlich.

Zur experimentellen Überprüfung der theoretischen Ergebnisse wurden mehrere Messungen mit unterschiedlichen Aufbauten durchgeführt. Die Unterschiede bestanden in der Verwendung verschiedener Konvertermaterialien die auch in der Schichtdicke variiert wurden und dem Einsatz von drei verschiedenen Röntgenpräparaten, die sich in der Energie ihrer Linien unterscheiden. Hierbei konnte eine sehr gute Übereinstimmung zwischen den berechneten und den experimentell bestimmten Ergebnissen festgestellt werden.

Aufgrund der vorhandenen sekundären Photonen, die durch den Übergang des Konverteratoms in den Grundzustand entstehen, war zu überprüfen ob die Erhaltung der Ortsinformation möglich ist oder nicht. Da eine Berücksichtigung der Sekundärprozesse aufgrund der komplexen Vorgänge analytisch nicht möglich war, wurden diese numerisch durch eine Monte-Carlo-Simulation untersucht. Das Ergebnis zeigte das die Erhaltung der Ortsinformation gewährleistet ist.

Um einen ersten direkten Vergleich mit kommerziellen Detektoren zu erhalten wurden, die in dieser Arbeit eingesetzten radioaktiven Präparate auch vor einen Flat-Panel-Detektor der Firma Perkin Elmer gestellt. Obwohl die bei diesem Detektortyp angegebene Effizienz bei 60-70% liegt, war es für den Anwender bei allen wählbaren Einstellungen nicht möglich ein messbares Signal zu erhalten. Diese Vergleichsmessung zeigt eindrucksvoll die hohe Dynamik des CASCADE-Detektors.

Ein weiterer Teil meiner Arbeit spannt den Bogen zurück zur ursprünglichen Anwendung dieses Detektorsystems, dem Nachweis von Neutronen. Mit ei-

CHAPTER 2. RESEARCH PROGRAM

nem CASCADE-Neutronendetektor wurde eine Messung zum Nachweis von Neutron-Spiegelneutron-Oszillationen durchgeführt. Die Existenz einer solchen Spiegelmaterie wurde 1956 von Lee und Yang vorgeschlagen, um trotz Paritätsverletzung zu einer Symmetrie in der Beschreibung des Universums zu gelangen. Außerdem ist ihre Existenz eine Möglichkeit, einen Teil der nicht nachweisbaren Materie im Universum zu erklären. Bei der im Rahmen dieser Arbeit durchgeführten Messung handelt es sich um eine erste Testmessung zur Bestimmung der Neutron-Spiegelneutron-Oszillationszeit, die am RESEDA-Spektrometer des Forschungsreaktors II in München durchgeführt wurde. Eine wichtige Anforderung wurde bei dieser Messung an den Detektor gestellt. Dieser musste, um bei der Messung zu einem kleinen statistischen Fehler zu gelangen, hochratentauglich sein und damit eine geringe Totzeit aufweisen. Darüberhinaus sollte auch die Effizienz des Detektors die Statistik nicht limitieren. Durch den Einsatz des CASCADE-Neutronendetektors konnten diese Kriterien erfüllt werden. Hiermit konnte als untere Grenze der Oszillationszeit 2.72 s bestimmt werden.

2.2.5 Report by stipendiary Jan de Cuveland

Subject	Online Track Reconstruction of the ALICE Transition Radiation Detector at LHC (CERN)
Supervisor	Prof. Dr. V. Lindenstruth
Status	ongoing
Duration	2004-10-15 until 2008-02-29
Age at entry	27 years

Description of the PhD project and achieved research results

The Transition Radiation Detector (TRD) is one of the main detectors of the ALICE experiment at the LHC. One of its primary objectives is to trigger on high-momentum electrons.

The trigger complexity is considerable and requires fast event reconstruction. Based on data from 1.2 million analog channels, the reconstruction must be performed within 6 μs to contribute to the Level-1 trigger decision. After preprocessing the analog data and applying pattern-matching algorithms, the resulting track segments of different chambers must be reassembled three-dimensionally. From the curvature of the reconstructed tracks, the momentum of the originating particle is calculated to finally make the trigger decision. This part of the online processing must be completed in less than 2 μs .

Within the scope of my project, I have developed a hardware architecture which is able to perform the processing of up to 20 000 track segments in the required time by means of massive parallelism. The aim for low-latency data transmission, track reconstruction and data compression influences all parts of the design. To this end, several specific techniques had to be conceived

2.2. REPORTS OF THE STIPENDIARIES

ranging from low-latency bus protocols to custom track reconstruction algorithms specifically optimized for hardware implementation.

The trigger hardware consists of several specifically developed components. The track-matching unit is one of its main building blocks. It is an FPGA-based system utilizing PCI and 12 fibre-optical SFP transceiver interfaces, realized as a CompactPCI plug-in card. The main FPGA is a large, up-to-date chip which includes integrated multi-gigabit serializer/deserializer and PowerPC processor blocks. A total of 90 of these track-matching units together with additional components for low-latency data concentration and read-out form the ALICE TRD online tracking and read-out system *GTU* (Global Tracking Unit). The aggregate data rate at the input of this system is 2.16 TBit/s via 1080 fibre-optical links.

The complete system has been built and installed at the LHC at CERN and has entered continuous operation. Joint tests with other ALICE systems have been very successful. Analyses with Monte-Carlo simulated event data prove that the chosen design achieves a precision of $\langle \Delta p_t / p_t \rangle = 2.1\%$ in the online reconstruction for particles with transverse momenta of $p_t > 3$ GeV/ c and meets the timing requirements of the experiment.

Cooperation with respect to other projects

The IRTG has intensified existing cooperations with other projects in the context of the LHC/ALICE. In the course of my work, I have participated in cooperations with (amongst others):

- Institut für Kernphysik, Westfälische Wilhelms-Universität Münster
- Physikalisches Institut, Ruprecht-Karls-Universität Heidelberg
- Institutt for fysikk og teknologi, Universitetet i Bergen
- ALICE Data Acquisition, ALICE Central Trigger Processor (CTP), and ALICE High-Level Trigger projects at CERN

Study Program Attendance

I attended the following courses within the IRTG:

IRTG Workshop on *The Onset of deconfinement in nuclear collisions* Bergen, 2005-04

IRTG Lecture Week on *Programmable hardware and hardware programming* Heidelberg, 2005-09

IRTG Lecture Week *Introduction to high energy particle and nuclear physics* Oslo, 2006-03

IRTG Workshop on *Frontiers of Particle Identification* Heidelberg, 2006-10

IRTG Lecture Week on *Data acquisition and trigger systems* Bergen, 2007-04

CHAPTER 2. RESEARCH PROGRAM

Supervision in the IRTG

The participation in the International Research Training Group *Development and Application of Intelligent Detectors* has supported my work in many different ways. The weekly seminars have not only given me the opportunity to gain knowledge about a variety of specific topics related to modern particle detectors and their applications and to learn from the experiences of my fellow stipendiaries. They have also led to valuable discussions and contacts to other researchers working on similar problems. In addition, I have been given the opportunity to present my own work a couple of times in the course of the IRTG. This has always been a good chance to receive input and comments from a group of specialists and to further improve my presentational skills.

While attending the lecture weeks and courses within the IRTG, I have been studying several especially interesting topics, some of which are very relevant for my own work. The courses included a broad range of subjects ranging from fundamental physics questions to hands-on hardware development. The combination of sciences required for intelligent detectors (primarily physics and computer science) has been well reflected in the diversity of courses. While I was able to tutor exercise groups in the Fall 2005 lecture week, I have gained various rewarding insights while attending the other courses.

Stays abroad

Research stay at the *European Organization for Nuclear Research* (CERN) in France from August 2007 (currently ongoing)

2.2.6 Report by stipendiary David Emschermann

Subject	Infrastructure and Commissioning of the ALICE Transition Radiation Detector
Supervisor	Prof. Dr. J. P. Wessels
Status	ongoing
Duration	01-11-2004 until 31-12-2007
Age start	29 years

Description of the PhD project and achieved research results

As part of my PhD within the IRTG, I am taking care of the planning, installation and support of infrastructure required for commissioning and operation of the ALICE Transition Radiation Detector. The following sub-systems are covered by my work :

- Ethernet network for the TRD DCS
- Optical fiber and cabling infrastructure

2.2. REPORTS OF THE STIPENDIARIES

- LV system - purchasing, installation and commissioning
- HV system - purchasing, installation and commissioning
- Data acquisition system for the TRD testbeam 2007

The full TRD consists of 670 Ethernet devices (581 DCS boards and 89 LV power supplies) operating in a private DCS network. The backbone of the TRD part is built by 31 Ethernet switches. The device mapping has been defined and DNS/DHCP server information collected.

The service infrastructure of the TRD comprises of more than 1400 individual connections : low voltage cables, sense wires, high voltage multiwire cables, Ethernet links and optical fibres. Information required for the installation of the full infrastructure was provided in a database and the installation is being monitored.

Low voltage power is supplied to the TRD through 89 power supplies offering a total of 224 channels. An optimisation of the LV distribution layout allowed to spare 8 power supplies. As of October 2007 more than 60% of the power supplies are installed and operational, the installation will be completed until the end of 2007. A power-up procedure for the full TRD detector has been defined.

In the beginning of 2007, an alternative had to be found for the HV system of the TRD. A custom design module – derived from the ATLAS type – has been defined in collaboration with industry. Production and installation of all TRD HV modules will be completed in time before the start of LHC operations.

A full TRD super module will be tested in beam for the first time in November 2007. For this beam test I have designed and setup a distributed DAQ system operating DATE version 6.11 (see figure 2.7). The system will read-out the TRD super module through the Global Tracking Unit. It can also record data from 3 monitoring detectors, a pair of Silicon strip detectors, a Cherenkov detector and a lead-glaess calorimeter, readout via ADCs in a VME crate. An interface to the HLT is also available.

Cooperation with respect to other projects

Cooperation with ALICE PHOS group (Oslo, Norway) and ALICE HLT group (Bergen, Norway).

Attendance at the study program

My participation in study programs in the frame of the GRAKO :

- 30.03.2005 - 06.04.2005 - Bergen IRTG school '2nd International Workshop on the Critical Point and Onset of Deconfinement'

CHAPTER 2. RESEARCH PROGRAM

DAQ setup for TRD testbeam 2007

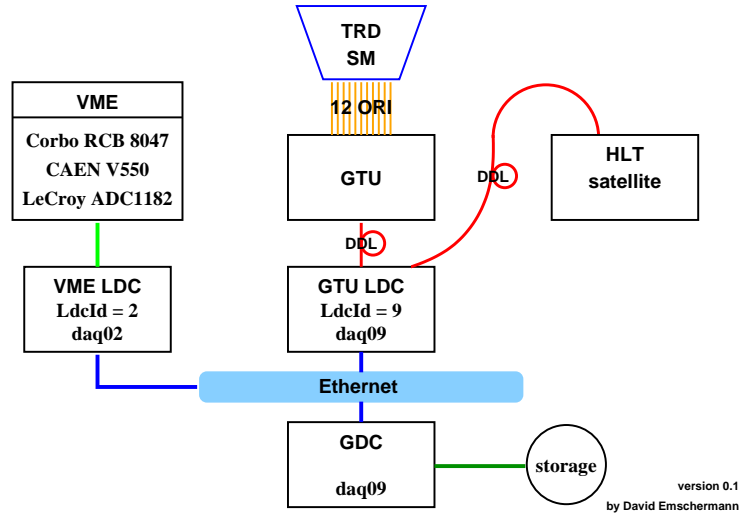

Figure 2.7: Data acquisition system for the TRD testbeam 2007

- 17.09.2005 - 21.09.2005 - Heidelberg IRTG school 'Programmable hardware and hardware programming'
- 06.03.2006 - 10.03.2006 - Oslo IRTG school 'Introduction to high energy particle and nuclear physics'
- 11.04.2007 - 15.04.2007 - Bergen IRTG school 'Data acquisition and trigger systems'
- 17.09.2007 - 18.09.2007 - Oslo IRTG school 'Workshop on 3D-detectors and electronics'

Supervision in the IRTG

Throughout my membership to the IRTG I have profited a lot of the vivid atmosphere and support in the group. The workshops and lecture weeks in the framework of the Grako have always been very interesting and stimulating. They have brightened up many topics and gave rise to impulses on quite a number of new subjects. Also these occasions were great opportunities to forge and intensify links with our Norwegian colleagues.

Presentations and conferences

- *A review of TRD CERN beam time 2004*, TRD collaboration meeting, GSI Darmstadt, Germany - 04.02.2005

2.2. REPORTS OF THE STIPENDIARIES

- *TRD CERN beam time 2004*, ALICE week - DAQ meeting, CERN, Geneva, Switzerland - 28.02.2005
- *First beam test with a real size, six layer series production detector stack for ALICE TRD*, Group report, DPG Fruehjahrstagung 2005, Berlin, Germany - 08.03.2005
- *Advanced Supermodule Integration planning and HV system status*, International workshop TRD Present and Future, Cheile Gradistei, Romanina - 27.09.2005
- *Supermodule Integration and Perspectives of ALICE TRD*, IRTG Lecture week 2006, Olso, Norway - March 2006,
- *Preparing for TRD pre-commissioning with ECS and DAQ*, ALICE week - DAQ meeting, CERN Geneva, Switzerland - 14.03.2006
- *The TRD Ethernet network at Point 2*, DCS workshop, PI, Heidelberg - 22.01.2007
- *Howto power up the TRD*, DCS workshop, PI, Heidelberg - 22.01.2007
- *Commissioning of the first ALICE TRD super module installed at CERN LHC*, DPG Fruehjahrstagung 2007, Giessen - 13.03.2007
- *Status of TRD services at Point 2*, TRD collaboration meeting, Rolandseck 30.03.2007

2.2.7 Report by stipendiary Andreas W. Jung

subject	Commissioning and Optimization of the H1 Fast Track Trigger with respect to its use of selecting heavy quark events and analysis of heavy quark production in ep-scattering.
Supervisor	Prof. Dr. H.-C. Schultz-Coulon
status	on-going
duration	15.11.2004 till 14.11.2008
age at start	26 years

Introduction

The H1 detector [309] is installed at one of the four possible interaction points of the HERA accelerator in Hamburg. At the H1 interaction point electrons (positrons) are collided with protons and the interaction products are measured and analyzed. In the year 2000 an upgrade program (HERAII phase) was performed which resulted in a luminosity increase by a factor

CHAPTER 2. RESEARCH PROGRAM

five. In order to cope with the increased data and background rates the Fast Track Trigger (FTT) [310, 311] was built. The FTT selects track based topologies in a high track multiplicity environment efficiently. The selection of events containing charm quarks is of special interest because these events are directly sensitive to the gluon density and the structure of the proton. For the selection of charm-events it is necessary to select track-based exclusive final states at the earliest possible trigger stages. The FTT was designed for this purpose.

In order to reach the necessary high selectivity the FTT was built as a three level trigger system with the stages L1, L2 and L3. At the first trigger stage the analog signals of special wire layers of the H1 central jet chambers are digitized and used for a coarse two-dimensional track reconstruction. The L1 Trigger decisions are based on the reconstructed track parameters. If the event is accepted from the H1 level one global trigger decision the FTT-L2 system performs a very precise three dimensional track reconstruction comparable to the off-line one. With these track parameters a FTT-L2 trigger decision is made. If the event is accepted by L2 a track based event reconstruction is made at FTT-L3. It uses the track parameters from FTT-L2 to calculate invariant masses of combined tracks. Meson and baryon resonances are identified and selected with cuts in the invariant mass spectra. In addition FTT-L3 is able to do a particle identification for leptons. This is possible with the reception and processing of data from other detector systems, e.g. calorimeter or muon system data.

Description and results of my Ph.D. (Hardware part)

The first part of my Ph.D. was devoted mainly to the commissioning and optimization of the FTT. The first trigger stage of the FTT worked reliable [313] since end of the year 2004 and has replaced the old H1 track trigger (Dcr ϕ -Trigger) in the year 2005. The commissioning of the second trigger stage of the FTT has been finished in the year 2005 [314]. In order to get very precise track parameters which are needed for FTT-L3 substantial studies and further optimizations for FTT-L2 followed.

During the commissioning of FTT-L2 (August 2005) the commissioning of the third stage of the FTT was started [316]. First of all the successful and accurate data transfer of the FTT-L2 data to the L3 system was established. A so-called multi-purpose board (L2 Decider card) was used to transfer the data. I have developed different data transfer tests to benchmark the error rate. In order to make use of the L3 trigger decisions the connection to the H1 central trigger logic was installed and tested [315]. Amongst others new interface cards with increased functionality have been produced and successfully integrated into the L3 system. The installation and commissioning of the L3 system was the key activity during the hardware part of my Ph.D. and was finished in April 2006.

2.2. REPORTS OF THE STIPENDIARIES

The FTT-L3 system has provided a global reject signal which aborts the whole H1 detector readout. Because of that all H1 subsystems have been adjusted to the new situation. In order to check the utilization of the L3 reject signal by the H1 detector the decision was calculated but not used (transparent phase). With the successful end of these studies the L3 reject signal was activated in August 2006 and the full functionality of the FTT system was used [317].

Due to the continuous optimization of the H1 trigger system also the FTT system was further optimized and minor bugs have been solved. The studies needed to monitor FTT efficiencies and data quality of the triggered data provided a smooth transition to the second part of my Ph.D., which is the physics analysis part.

Because of a transverse momentum threshold as low as 100 MeV at high track efficiencies the FTT is well suited to trigger the charmed D^* meson decay into a kaon, a pion and a slow pion ($D^* \rightarrow D^0 \pi_{slow} \rightarrow K \pi \pi_{slow}$). It has been shown that the L3 trigger efficiency is about 50% and flat in the whole $p_t(D^*)$ -spectrum [318]. The achieved performance matches the one derived from studies concerning the possible realization of a Fast Track Trigger made in 2001 [310]. In total a sample of approximately 12000 D^* s has been collected and provides a factor ten increase in statistics and a significant enlarged phase space compared to previous analysis at H1. The measurement permits an analyses of the proton structure or to be more precise of the gluon density of the proton.

Latest activities in my hardware part are the integration of the FTT simulation in the global H1 detector simulation and the publication of the functioning of the L3 system in Nuclear Instruments and Methods (in preparation: *The Third Level of the H1 Fast Track Trigger*).

Description and results of my Ph.D. (Analysis part)

In ep-scattering processes the production of charm quarks is of particular interest because they are suppressed intrinsic in the proton. These events permit conclusions on the gluon density of the proton with the benefit of a significantly larger production rate compared to beauty-events.

With the start of my Ph.D. I have developed a routine that reproduces the measured charm production cross sections. The routine was integrated into the HZTOOL library in the scheme of the HERA-LHC workshop [312] providing easy access and test environment of MC generators. The development of this routine has deepened my understanding of the functioning of MC generators and of the theory of heavy quark production and is of use of for my analysis of charm events.

At the beginning of the year 2007 I have started an analysis of the cross section of the production of D^* mesons in deep inelastic scattering. Thereby the whole statistic of 350 pb^{-1} (HERAII phase) is used. The aim of the

CHAPTER 2. RESEARCH PROGRAM

analysis is to provide precise cross section measurements in single and double differential distributions in order to compare to theoretical predictions at leading and next-to-leading order QCD. In addition the precise cross sections can be used to determine the charm structure function of the proton providing conclusions on the gluon density of the proton.

Participation in study programs

IRTG schools on:

- 'Programmable hardware and hardware programming', September 2005, Heidelberg
- 'Introduction to high energy particle and nuclear physics', March 2006, Oslo, Norway
- 'Frontiers of particle Identification', October 2006, Heidelberg
- 'Data Acquisition and Trigger Systems', April 2007, Bergen, Norway
- '3D detectors', September 2007, Oslo, Norway

CERN school:

- CERN 'European School for High Energy Physics', July 2006, Stockholm, Sweden

Participation at the DPG-Conferences of the years 2004-2008 (talks listed at the bottom)

Heidelberger graduate days of the years 2004-2005

Supervision in the IRTG

The participation at the graduate schools offered me insights in technical solutions of other HEP experiments. These insights I have used to solve problems arising during my commissioning work of the FTT faster and more efficient. Amongst others the practical orientation of the graduate schools ('hands on ...') allowed me to answer special questions of my daily work within the graduate schools (fall 2005 and spring 2007). The participation has enriched my knowledge in modern tracking and novel detector concepts significant. Also the social component originating from the discussions with the norwegian colleagues I would like to mention here.

Stays abroad

IEEE NPSS RealTime 2007 in Chicago, USA

Stays in the scheme of the graduate schools

Publications

[\[311\]](#) [\[312\]](#) [\[313\]](#) [\[314\]](#) [\[315\]](#) [\[316\]](#) [\[317\]](#) [\[318\]](#)

2.2. REPORTS OF THE STIPENDIARIES

2.2.8 Report by stipendiary Jan Knopf

Subject	Commissioning of the LHCb Outer Tracker electronic
Supervisor	Prof. Dr. U. Uwer
Status	ongoing
Duration	1-12-2004 until 1-6-2008
Age at start	27 years

Description of the PhD project and achieved research results

The LHCb experiment is one of the four main detectors operated at the LHC machine at CERN. It is a dedicated experiment to study the decay of rare B meson. This thesis is carried out in the context of the Heidelberg participation in the development and the construction of the LHCb Outer Tracker (OT) sub-detector.

The Outer Tracker plays an important role in the reconstruction of charged particle tracks. It is build out of drift chamber modules with a length of 5 m. Each module is read out at both ends. The detector signal is generated by the ionisation of the drift gas within a straw tube. The electrons from these ionisation clusters drift towards an anode wire. The large field gradient in this environment leads to additional ionisation electrons and therefore creating an electron avalanche. This avalanche is detected by the electrical readout, which measures the arrival time of this signal with respect to the LHC beam crossing. This drift time measurement allows the determination of the impact point of the ionising particle.

In order to perform this task the OT readout electronic consists of three major components: The amplifier discriminator (ASDBLR), the OTIS-TDC chip and the GOL serialiser chip (see figure 2.8). The heart of the system is the OTIS-TDC chip, an ASIC especially designed to sample the drift times of 32 module channels. For each channel a new measurement is started every 25 ns, which is the nominal LHCb bunch crossing frequency. The drift time is resolved with 6 bit and therefore better than 1 ns within every click cycle. The final stage in the OT Front-end electronic is the GOL-Aux board. It collects the data of four OTIS-TDC (128 channels) and transmits it via an optical fibre. It also provides all services to the electronic such as the timing and trigger signals, the slow control communication via I^2C , the distribution of test pulses and power supply.

Both the OTIS-TDC chip and the GOL-Aux board have been designed and produced in Heidelberg. As a part of my thesis project i have developed test setups to allow precise and fast tests of all produced OTIS-TDC chips and the produced GOL-Aux boards.

The OTIS chips had to be tested before the silicon wafer was diced. A semi-automatic wafer prober was used to contact the individual chips and to step over the wafer. As the amount of data necessary to check all the needed features of a chip could reach up to 250 MB, the test sequence was

CHAPTER 2. RESEARCH PROGRAM

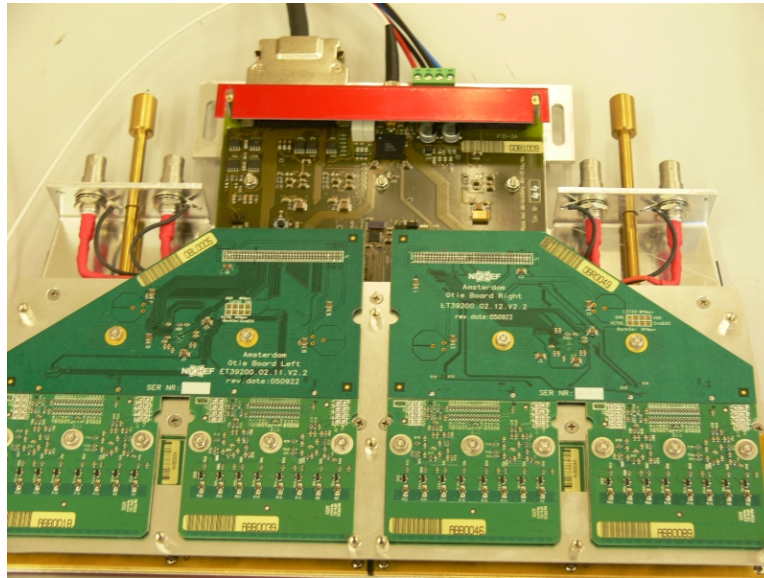

Figure 2.8: this picture shows an open Front-end box. Four ASDBLR boards are visible at the bottom. Two of these boards are connected to one OTIS board, where the time measurement takes place. Two more OTIS and four more ASDBLR boards are located at the backside, which are not visible in this picture. At the top you can see the GOL-Aux board. This board provides the connections to the outside world such as the optical fibre or the power cables. To the left and right of the GOL-Aux board one can see the HV connections and the screws to mount the complete box.

implemented into a FPGA. The control of the FPGA was realized with a LabViewTM application. The whole setup containing the wafer prober, the power supply and the PC containing the FPGA was steered by a second LabViewTM application on a separate PC. By analysing the data on the FPGA we were able to achieve a round-trip time per chip of ~ 1 min. In this way it was possible to test all 7332 chip of the production in just under three weeks time. The achieved yield was 90 %.

The GOL-Aux boards were tested in a setup with four validated Otis Boards and vis versa. The data produced by the OTIS chips were serialised and sent by the GOL-Aux board to an optical receiver. After the conversion back into electrical signals, they were processed by a FPGA. Within the FPGA the data was first checked for validity and then put into the according histograms. This way only the result of a test had to be transferred via the PCI-Bus. In order to simplify the setup even more, the complete slow control for the OTIS chips was also implemented into the FPGA. Therefore the complete test sequence could be automated with a program informing the FPGA about the test to be performed and receiving the result. This

2.2. REPORTS OF THE STIPENDIARIES

program provided an user interface to start a test and stored the result for each board in an internal database. Thus all the necessary components were integrated into one PC providing an easy execution of the test. The 500 GOL-Aux boards were tested in Heidelberg at the Physikalisches Institut with 466 boards passing all test criteria. A second realization of this test setup was shipped to our partner institute in Amsterdam and used to test the OTIS board tests.

I have also actively participated in the commissioning of the electronics. Several setups with an increasing number of hardware components have been built. In February 2005 four drift chamber modules equipped with the final electronic were operated for the first time at a test beam facility in Hamburg. This test included the complete read out chain from the modules to the receiving of the optical data. As the clock signal of 40 MHz could not be used as a reference for the time measurement, the trigger signal generated by two scintillators was feed into one Otis chip. A second trigger with a fixed delay of 125 ns was then used to read out this reference time value. Throughout the test period of two weeks we were able to record data testing both the performance of the electronics as well as the drift chamber modules. Being able to determine the beam position in a modules with a resolution better than the design value of 200 μm shows the successful operation of the complete setup.

In September 2006 the final versions of the hardware components providing the control signals for the Front-end electronic became available. After the integration of this components into the setup, the focused shifted from getting the hardware to work fully reliable to the development of test procedures to check the status of the hardware. These procedures were then used during every phase of the electronic installation into the detector starting in December 2006. Utilising the Commissioning Rack of the LHCb Online Group, which portrays the final experiment system on a small scale, a stand-alone operation at the experiment site was possible.

Several studies have been undertaken since. They reach from measurements of the noise behaviour, the time measurement of the OTIS-TDC in this environment to the longtime stability of injected test pulses with respect to time and temperature. So far the electronic shows full capability and no major problem has been found.

Since July 2007 the focus of my work shifted towards the preparation of the data analysis. My research topic is the measurement of the $B_s \rightarrow \phi\phi$ decay. Around 20 000 of such signal events are expected within 10 fb^{-1} of data collected at LHCb. As the standard model predicts no CP-asymmetry for this decay, the observation of a CP-violation in this channel would indicate “new physic”. After making myself familiar with the LHCb software framework, a signal sample is studied to evaluate the power of individual cuts. As a background sample a inclusive $b\bar{b}$ is currently chosen. It is planned to

CHAPTER 2. RESEARCH PROGRAM

study also other sources of background such as $c\bar{c}$ events in the near future.

Cooperation with respect to other projects

Cooperation with NIKHEF in Amsterdam, The Netherlands

Cooperation with the University of Dortmund, Germany

Attendance at the study program

Heidelberg IRTG school on 'VHDL Graduate Courses' in the frame of the GraKo

Heidelberg IRTG school on 'Frontiers of Particle Identification' in the frame of the GraKo

Bergen IRTG school on 'Data acquisition and trigger systems' in the frame of the GraKo

Supervision in the IRTG

Since a big fraction of my work was dedicate to a develop FPGA firmware for our test, the school on VHDL was the one with the most benefits for me. The bi-weekly seminars during the semesters offered a nice introduction to other experiment, especially the ones located at CERN, and their solutions to similar problem I faced during the testing of our electronic.

Stays abroad

... for various setups of tests for our electronics.

Location	Dates
Genf, CERN	6-8.6.05, 9-14.10.06, 23-27.10.06, 6-10.11.06, 27.11.06-1.12.06, 18-22.12.06, 22.1.07-1.2.07, 12-16.3.07, 18/19.4.07, 4-7.6.07
Hamburg, DESY	17.2.05-1.3.05, 9/10.3.05
Amsterdam, NIKHEF	11-15.4.05
Dortmund	20-22.9.06
Valencia	25-30.9.06

Publications

[286]

2.2.9 Report by stipendiary Andreas Reischl

Status	ongoing
Duration	15-7-2007 until 31-3-2009
Age start	36 years

2.2. REPORTS OF THE STIPENDIARIES

Description of the project and achieved research results

I am participating in the coordination of the CBM - TOF R&D effort, trying to make use of the expertise in the IRTG as much as possible. Currently the FOPI group, that represents the scientific environment for my research, operates an RPC - TOF barrel of 4600 timing channel with the world best resolution reported so far ($\sigma_{t\text{sys}} \leq 95\text{ps}$). This existing detector concepts is undergoing a further improvement in terms of performance both on the timing resolution as well as the rate capabilities. For these studies a detector test stand has been build up in Heidelberg to quantify the detector performance with respect to the used gas mixtures. Furthermore, the test setup is expanded right now with additional silicon detectors to get a handle on the spacial performance. This extension will already be equipped with 'intelligent' front-end electronics and serves as a test case for those components upcoming experiments. In addition, the data acquisition (DAQ) system will be expanded to also test capabilities of new concepts of how to cope with high rate. At the last stage the system is supposed to test the whole chain of next generation experiments starting from the fast detectors with high rate capabilities, the intelligent front-end electronics that can cope with these rates and serve a data driven acquisition system.

My physics research focuses on strangeness production at SIS energies. Here I benefit for the experience of the IRTG and especially that of the Bergen group of Röhrich. Meanwhile there exists a very good exchange between my institute and the other. Also in view of upcoming experiments dealing among other things with strangeness I profit from my work in the IRTG as we are going to use the newly developed silicon detectors as beam trackers. First studies done in 2007 showed the feasibility of the concept and as explained earlier we are now building those silicon detectors at the PI. Through this broad collaboration of the IRTG it was only possible to extend our contact to even more institution and we could get the silicon pieces for free with additional support form Strasbourg and Torino.

As I just came to the PI in HD with the start of my contract the large group of scientist in the IRTG open from the first day a big network of researchers and scientist within the University of Heidelberg PI and Kip and to Oslo and Bergen to me. The many different subjects of the PhD students inspire and broaden my knowledge especially in view of the informatics and electronics.

Since so many groups are involved into CBM already, the IRTG represents an ideal place exchange conceptual ideas in an early phase and stimulate inputs from the young researchers.

Building a beam tracking silicon detector for the FOPI experiment. First test measurements of silicon strip counters utilizing a strontium source (see figure 2.9).

CHAPTER 2. RESEARCH PROGRAM

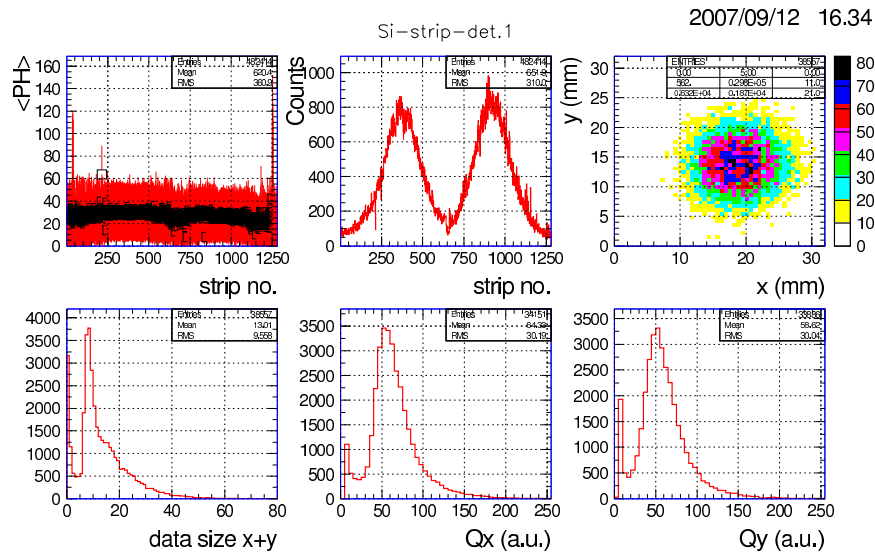

Figure 2.9: Strontium source on silicon detector; plane one.

Cooperation with respect to other projects

Cooperation with SINTEF laboratory in Oslo, Norway for radiation hard silicon detectors. Cooperation with the group of Lindenstruth and Kepschul at the KIP with respect to the implementation of intelligence into front-end-electronics utilizing FPGA's.

Attendance at the study program

Oslo IRTG school of '3D detectors' in the frame of the GRAKO. The regular IRTG seminar at the Physikalisches Institut.

Supervision in the IRTG

nice

Stays abroad

September 2007 IRTG workshop on 3D-detectors in Oslo.

Presentations and Publications

I have presented my work on collaboration meetings and in the so called 'Palaver Afternoon' at the Physikalisches Institut Heidelberg. The first results appeared in the GSI annual report 2007: I. Deppner et al *MRPC resolution and efficiency studies*.

2.2. REPORTS OF THE STIPENDIARIES

2.2.10 Report by stipendiary Felix Rettig

Subject	A jet trigger for the ALICE TRD Global Tracking Unit
Supervisor	Prof. Dr. V. Lindenstruth
Status	ongoing
Duration	2007-07-01 until 2000-03-31
Age at entry	30 years

Description of the PhD project

The PhD work is carried out in the framework of ALICE (A Large Ion Collider Experiment), the heavy ion experiment at Large Hadron Collider currently built at the European Laboratory for Particle Physics (CERN), starting operation in 2008.

One of the detectors in ALICE is the Transition Radiation Detector (TRD). Designed as a fast detector for high-momentum leptons, it comprises of many small drift chambers equipped with radiator material on the inner sides.

By means of massive parallel processing in the front-end electronics situated on top of the chambers, stiff track segments are identified shortly after the event. Additionally, based on the charge time response a distinction between electrons and pions with same transverse momenta is done. Segment parameters and associated particle identification information are transferred to the Global Tracking Unit (GTU) with very low latency.

Built of more than hundred modules carrying high-performance FPGAs¹, the GTU is able to perform track and momentum reconstruction very fast. It's main purpose is to calculate the TRD's contribution to the second level trigger of ALICE.

The large amount of track and particle data available in the powerful, highly-programmable FPGA architecture exhibits exciting opportunities to implement complex trigger schemes for rare physics events in hardware, still meeting the strict timing requirements.

The first milestone within the PhD project is to bring forward the development of the GTU for commissioning. Based on results of the first beam time, improvements to the current heavy ion trigger scheme may be applied. Subsequently, the main topic of my PhD work will be to devise, implement and characterise more complex trigger schemes. Emphasis will be put on jet triggers for proton-proton collisions.

Co-operation with other projects/groups

Participating in the IRTG laid the foundation for a more intense co-operation with the following groups, mostly within the framework of the ALICE collaboration:

¹FPGA: Field Programmable Gate Array

CHAPTER 2. RESEARCH PROGRAM

- Oslo Cyclotron Laboratory, Fysisk institutt, Universitetet i Oslo, Norway
- Heavy Ion Physics Group, Physikalisches Institut, Ruprecht-Karls-Universität Heidelberg
- Relativistic Heavy Ion Physics Group, Institut für Kernphysik, Westfälische Wilhelms-Universität Münster
- High Level Trigger Group, Kirchhoff-Institut für Physik, Ruprecht-Karls-Universität Heidelberg
- ALICE Data Acquisition and Central Trigger Processor Groups, CERN

Attendance at events of the programme

Besides the regular meetings at Heidelberg with talks of stipendiaries and invited speakers, I attended one workshop so far.

1. IRTG Workshop on 3D detectors, Oslo, September 2007

Supervision in the IRTG

Participating in the programme offers a great deal of opportunities to gain new ideas and improve knowledge by exchanging with fellow PhD students as well as experienced scientists. The regular meetings with talks given by other stipendiaries or invited speakers provide interesting insights into the approaches of other research groups. The mix of different subjects ranging from technology topics to theoretical physics brings forward a more complete understanding of all aspects of modern detectors and related research topics. The workshops and schools allow to deepen the knowledge about dedicated topics and provide an even wider framework for sharing ideas, communicating current research activities and broadening the view of the development of and requirements to intelligent detectors.

2.2.11 Report by stipendiary Frederik Rühr

Subject	TeV Jets at ATLAS: A probe for new physics
Supervisor	Prof. Dr. K. Meier
Status	ongoing
Duration	01-01-2005 until 30-06-2008
Age @ start	25 years

Description of the PhD project and achieved research results

My work on the ATLAS project is twofold. On the hardware side I contributed to prototype tests and the commissioning of the ATLAS Level-1

2.2. REPORTS OF THE STIPENDIARIES

Calorimeter Trigger. My analysis work is focused on highest energy particle jets, their measurement, calibration and use as a probe for new physics beyond the Standard Model.

The ATLAS trigger consists of three stages, the Level-1 Trigger, Level-2 and the Event Builder. The last two are often commonly referred to as High Level Trigger and are implemented as software algorithms on computer clusters. The first level trigger is a hardware trigger, relying on Application Specific Integrated Circuits and Field Programmable Gate Arrays for the processing of incoming signals and the trigger algorithms. Its task is to reduce the event rate from 1GHz (at high design luminosity) to below 100kHz, and thus select a maximum of one event in 10000. Conceptionally it is further subdivided into the Calorimeter Trigger, receiving 7200 input signals from the ATLAS calorimetry, the Muon Trigger and the Central Trigger Processor, which reaches the Level-1 Trigger decision based on the output of the other two subsystems.

After finishing my Diploma Thesis on integration tests of several components and external interfaces of the Level-1 Calorimeter Trigger (L1Calo) during a series of slice-tests, the focus of my work was first moved in 2005 to the tests and optimizations of prototypes for the last unfinished submodules of the L1Calo Pre-Processor. Finishing this work successfully and the system entering the production stage the requirement for a working slice of the Level-1 trigger at CERN marked the start of the commissioning phase in the ATLAS counting room.



Figure 2.10: Detail of a fully equipped Pre-Processor Crate

From module installation, cabling plans and work, integration of the Level-1 Calorimeter Trigger Preprocessor into the ATLAS timing and control system to combined tests with the rest of L1Calo and other ATLAS subdetectors, this work spanned to the end of 2006 for me, culminating in a nine month full-time stay at CERN in that year.

My analysis work for ATLAS started end of 2005 with early studies on the discovery potential of quark compositeness at the LHC using QCD-jet events. As a precise knowledge of the Jet Energy Scale (JES) is not only a

CHAPTER 2. RESEARCH PROGRAM

requirement for these studies, but also many other analyses in a Hadron collider experiment, from Q3 2006 onwards the search for and implementation of methods to verify and calibrate the JES at highest energies complement my work.

Many new physics scenarios, like e.g. a substructure of quarks, quantum gravitational effects or new particles like axigluons, influence the QCD dijet cross-section, often before manifesting in new particles or resonances. Thus the measurement of inclusive jet spectra or the dijet mass spectrum at ATLAS are vital tests of QCD and the Standard Model of Particle Physics. Apart from an expected increase in the inclusive jet cross-section at highest energies, due to either a definite size of quarks or an enlarged phase-space for exchanged particles, angular distributions of dijet events are also expected to change. As these angular distributions are largely independent from most detector and measuring effects, like non-linearities or miscalibration of the JES, dead material or cracks, they could prove a very useful tool for the discovery of new physics with earliest ATLAS data.

From my studies it is expected that e.g. limits on quark-compositeness derived by the Tevatron experiments can be surpassed with less than 100pb⁻¹ integrated luminosity of ATLAS data, which could be accumulated during the very first months of LHC operation.

The ability to discern between different scenarios beyond the standard model using dijet angular distributions is limited, though, making dijet mass spectra and inclusive jet spectra another critical tool. But for their use the JES is required to be precisely known up to jet transversal energies above 1 TeV. Especially with early data, proven in-situ methods to establish the JES are expected to fail in that regime due to insufficient statistics. Thus I examined different new approaches and developed one working method to utilize the huge QCD-jet cross-section to solve this problem. The basic idea is a selection of multi-jet events where one jet has significantly higher transversal energy (E_t) than all others. Using a low E_t region as base, where the JES has been verified by other methods, it is then 'bootstrapped' up to high E_t by balancing the leading jet in these events with the vector-sum of all others.

With Monte-Carlo data, using the full simulation of the ATLAS detector, my work has shown that this method performs nicely, resulting in uncertainties of the JES in respect to the base region being below 1 percent even with limited statistics. 'Bootstrapping' of the JES to higher jet E_t could prove to be a very valuable tool at ATLAS right from the start of data taking.

Cooperation with respect to other projects

While no tangible direct cooperation between my project and other groups participating in the IRTG took place, the regular and close contact was nonetheless cooperative and fruitful. Especially the mutual exchange with

2.2. REPORTS OF THE STIPENDIARIES

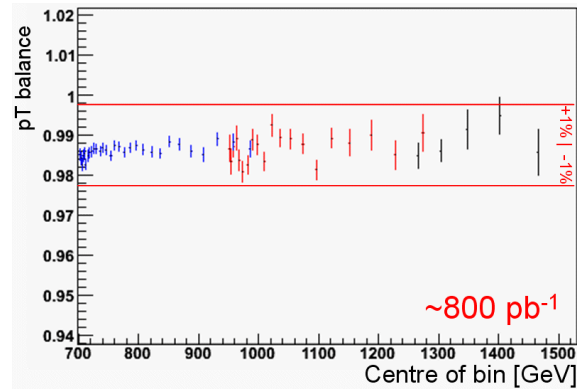

Figure 2.11: Verification and uncertainty of the JES after bootstrapping

members focusing more on information technologies proved to be very helpful for me, having more of a physics background. I gained not a only profound grounding regarding triggering, data acquisition and silicon detectors in high energy physics via lectures, workshops, presentations and informal discussions, across disciplines and experiments, but also critical insight into programmable electronics like Field Programmable Gate Arrays. Seeing different approaches to similar problems in high energy physics experiments, and having a pool of expertise far surpassing the capabilities of a single group available was extremely helpful.

Attendance of the IRTG Study program

- Fall 2005: Heidelberg IRTG VHDL Graduate Courses
- Spring 2006: Oslo IRTG Lecture Week 'Introduction to high energy particle and nuclear physics'
- Fall 2006: Heidelberg IRTG Workshop 'Frontiers of Particle Identification'
- Spring 2007: Bergen IRTG Lecture Week 'Data acquisition and trigger systems'
- Fall 2007: Oslo IRTG Workshop '3D-detectors and electronics'

Continuous participation in the IRTG seminar in Heidelberg.

Supervision in the IRTG

Due to the large numbers of faculty members from different groups in Germany and Norway taking part in the IRTG, supervision was good and

CHAPTER 2. RESEARCH PROGRAM

exceeded the possibilities of a single group. Peer supervision should also not go unmentioned, with a large number of colleagues from partly different but connected fields of expertise being available to help out, advise and discuss.

Stays abroad

During my time in the Training and Research Group I was living in Geneva, Switzerland from the start of April 2006 to the end of December 2006 to conduct commissioning and testing work for ATLAS L1Calo, and also to get into closer contact with the ATLAS physics groups.

Apart from that I was able to regularly go abroad for short stays, from the attendance of a large number of schools and workshops, including the above mentioned IRTG Study program but also e.g. ATLAS workshops and the 2007 European School of High-Energy Physics, and a countless number of meetings and work stays at CERN.

Talks, conference contributions and publications

I have presented several talks in the IRTG seminar, at ATLAS meetings and workshops and at the DPG spring meeting. Furthermore I have contributed to the IEEE-NPSS in the years 2007-2007 and LECC 2006/7. My publications are: [\[320\]](#) [\[319\]](#)

2.2.12 Report by stipendiary Rachik Soualah

Subject	Reconstruction of neutral pions in the CERES/NA45 experiment
Supervisor	Prof.Dr. Johanna Stachel
Status	ongoing
Duration	01-10-2005 until 01-10-2008
Age start	26 years

Description of the PhD project and achieved research results:

Here I present my research topic in the CERES experiment that I am working on for my PhD. I started work on my doctoral thesis in October 2005 in a data analysis project in the CERES/NA45 experiment where data from 30 million central Pb+Au collisions at 158 A GeV/c were recorded in the year 2000.

Research topics:

One of the goals of current nuclear researches is the observation of the Quark Gluon Plasma (QGP) where the universe consisted of quarks and gluons transforming to hadronic matter just few microseconds after the Big Bang. The only way to find evidence of QGP is to detect the remnants of the collisions where the composition of hadrons, leptons and

2.2. REPORTS OF THE STIPENDIARIES

photons tell us if a transition has occurred. Together with dileptons, photons constitute electromagnetic probes which are believed to reveal the history of the evolution of the plasma.

The photons play very important role to probe the early stages of the system evolution by providing important information about the dynamics and decay of the hot fireball formed in central nucleus-nucleus collisions. Heavy ion experiments aim to extract the thermal photons. This is done by subtracting the theoretically calculated contribution of prompt photons from the decay of mesons. At this stage the task is the separation of the direct photon from the large amount of photons coming from most π^0 and η decays. To accomplish this task one have to know the π^0 and η spectra with very high precision. Then we have to subtract the decay spectra from the inclusive spectra. One of the sources of systematics errors in the measurement of dilepton pairs in the low mass range, the main physics topic of the CERES experiment, comes from the fact that the η/π^0 ratio is not measured with a good accuracy at SPS energies yet for a direct photons analysis. The measurement of direct photons is a difficult task due to the large amount of combinatorial background. The WA98 experiment has reported a significant yield of direct photons above 1.5 GeV/c of pt by taking the ratio of measured photons to the combinatorial background. This results constituted the first observation of direct photons in ultrarelativistic heavy ion collisions. There was already one attempt in the CERES experiment pre-TPC era which yielded only an upper limit. In the PHENIX experiment, the photons were studied as well using the $\pi^0 \rightarrow \gamma\gamma$ decay channel by using the conversion method. We will be concerned with the reconstruction of photons that convert (shortly) before TPC into e+e- via measurement of the electron pair in the TPC. Here the physics interest will be to reconstruct neutral pion spectra and yields. The idea is to reconstruct the photons through conversions happening mainly in the RICH2 mirror (5 % of a radiation length). Next, it would be very desirable to extend this study to η mesons as well. There are no data available on production of η mesons in central Au-Au collisions at SPS energy in the literature.

The physics simulation and data analysis:

The physics simulation is divided into different parts, related to rates and geometrical acceptance and to issues of reconstruction efficiencies, resolution etc. The first part consists in a feasibility study of π^0 and η meson reconstruction in the CERES experiment.

- Using a kinematic generator, we studied the main characteristics of the π^0 and η meson distributions and those of their decay products
 - The acceptance of the experiment.

CHAPTER 2. RESEARCH PROGRAM

- (y vs pt) of π^0/η if the two electrons pairs produced by each of the two photons are in the TPC acceptance $0.12 < \theta < 0.24$.
- The momentum of the photon.
- The opening angle between the photons vs p_t of the π^0/η .
- To define a signature that is specific enough to discriminate the background, while keeping the signal with high efficiency, several distributions have been studied :
 - The opening angle of unlike sign pairs (e+ e-) and like sign pairs (e+ e+ + e- e-) in momentum bins in order to optimize the definition of the photon for efficiency and significance.
 - Using different dE/dx cuts for electron selection to optimize the efficiency and significance.
 - A secondary particle reconstruction scheme, based on the the reconstruction of the decay vertex, (primary vertex, secondary vertex) is applied to improve the significance.
 - Theta vs Phi distributions of the reconstructed photons for different photon definitions (see previous point).
 - Transverse momentum distribution of photons for different photon definitions.

In order to test the different cuts, the invariant mass of the two decay photons is reconstructed and the π^0 mesons (more abundant than η mesons) are used to study the significance of each selection step.

- Monte-Carlo simulations provide an invaluable tool for detailed understanding of backgrounds, resolution and efficiencies in the CERES experiment, and can be used to test hypotheses of detector and electronics response. However, in order to trust software for this kind of work, detailed validation of the simulation also needs to be performed.

Outlook:

The next step will be to create a sample of π^0/η , to understand efficiency, acceptance and systematic errors of the CERES analysis and track their decay products through the CERES experiment until digitized information is available. Finally these tracked π^0 and η decay products are overlayed to a full measured Pb-Au central collision event and the analysis software is used on this overlay event.

When this analysis will be finished for CERES, I want to use this technique in the ALICE experiment. The key detector in the central barrel of ALICE is also a TPC. It is natural to prepare the tools for the same type of π^0, η and photon analysis for proton and heavy ion collisions at LHC, although

2.2. REPORTS OF THE STIPENDIARIES

the actual data analysis would be beyond the scope and time scale of my thesis.

2.2.13 Report by stipendiary Jochen Thäder

Subject	ALICE HLT Commissioning and Jet Trigger
Supervisor	Prof. Dr. V. Lindenstruth
Status	ongoing
Duration	1-11-2006 until 31-12-2009
Entry	15-01-2007
Age start	27 years

Description of the PhD project and achieved research results

My PhD Project is taking place at the *High-Level Trigger* (HLT) of *A Large Ion Collider Experiment* (ALICE), which is one of the four experiments at the *Large Hadron Collider* (LHC) accelerator at the *European Laboratory for Particle Physics* (CERN) near Geneva, Switzerland. It is divided in a technical and a physics part.

In the first, technical part the focus is on the commissioning of the HLT, which is a multi-node, multi-processor computer farm for highly parallel online data reconstruction and compression. My main task in the commissioning is the assembling, implementing, testing and coordinating of the HLT setup for the first year of LHC p-p data taking. This includes the hardware setup of the computers as well as the network infrastructure and maintenance of the HLT cluster. Furthermore it also involves the development of software for run-control, data management and software management as well as analysis software and interfaces to other online systems. As the HLT is part of the ALICE online framework, the interfaces to the other online systems are crucial to the success of the HLT project.

The second part involves the implementation of a combined jet finder/trigger for the ALICE HLT. This jet finder/trigger will run online and use the combined track information from the *Time-Projection Chamber* (TPC) and the *Transition Radiation Detector* (TRD) in order to deliver a fast trigger decision. A high p_t jet trigger is needed because high p_t jets are rarely produced.

Cooperation with respect to other projects

The ALICE experiment is a collaboration of over 1000 people in 29 countries at the European Laboratory for Particle Physics (CERN). Especially the HLT project consists of members from Germany, Norway, India, Republic of South Africa and Italy.

CHAPTER 2. RESEARCH PROGRAM

Attendance at the study program

I attended the following study programs :

- IRTG Lecture Week - *Data Acquisition and Trigger Systems*, Bergen, April 2007
- IRTG Workshop - *3D detectors and electronics*, Oslo, September 2007

Supervision in the IRTG

Being a member of the GraKo is a great opportunity to exchange knowledge, technical progress and ideas to research related topics. The lecture weeks and workshops together with the universities in Norway on one hand offer a good possibility to learn from other, more general fields of research. New ideas and concepts which were presented have of course some influence in my normal research. On other the hand the regular seminars in Heidelberg with other PhD students giving updates of their research status and also the talks about general physics research are a great basis of exchanging with other PhD students in order to enrich the own skills.

Stays abroad

During my work for the HLT, I attended several ALICE and HLT related workshops and conferences in Norway, Italy and Switzerland. Furthermore since February 2007 I am continuously at CERN (Geneva, Switzerland), in order to organize and commission the HLT on-site.

Presentations

Several presentations have been given at ALICE meetings and workshops due to normal collaboration work.

Teaching

In order to improve my teaching skills, I teach a class of *Social skills in physics (Basiskurs für ein nachhaltiges Studium)* to first year physics students. In this class, the students learn basic soft skills, which they need in their scientific career.

2.2.14 Report by stipendiary Gerd Tröger

Subject	Improving Radiation Tolerance of FPGAs in High-Energy Physics Applications
Supervisor	Prof. Dr. U. Kebschull
Status	ongoing
Duration	April 2005 until March 2008
IRTG Entry	01-03-2005
Age start	28 years

2.2. REPORTS OF THE STIPENDIARIES

Description of the PhD project and achieved research results

The main goal of the PhD work is to prove the possibility of, using SRAM-based FPGAs in irradiated parts of high energy physics experiments, specifically in the Time Projection Chamber of the ALICE experiment at CERN. What makes SRAM-based FPGAs so interesting is that they provide computational power comparable to ASICs at a fraction of the cost and development time, on the other hand they are difficult to employ in irradiated environments because radiation does not only damage them in the same way ASICs are typically affected (Single Event Upsets, Latch-Ups, etc.), but they are also sensitive to upsets in their SRAM-based configuration memory leading functional errors.

To achieve this goal, the following key steps were necessary:

- Radiation testing of hardware candidates
- Radiation testing of methods to improve the radiation tolerance of SRAM-based FPGAs
- Determining the limits of their operation, and the limits of the improvement methods
- Determining constraints to the designs running on the FPGAs
- Modeling of the behavior and the methods
- Simulation to study the models and further study the methods
- Development of a concept for integration into the experiment electronics
- Verification of the methods for application with new/future technology

After the initial irradiation tests were successfully completed, and showed that the proposed methods would indeed enable the use of SRAM-based FPGAs in the ALICE TPC, the hardware requirements to support them were determined to enable a redesign of the previous TPC Readout Control Board, where they were supposed to be used. Subsequently, additional irradiation tests confirmed and reassured the previous results. Testing of the improvement methods showed clear limitations of some of the methods. The combined results of the hardware tests and testing of the improvement methods allowed us then to provide a concept for successfully employing the FPGAs in the TPC RCU. The concept has been implemented and integrated system tests have confirmed our expectations for it to work in the experiment.

Currently, the final steps for the verification of the methods for a new generation of FPGAs is under way, and expected to be completed soon.

CHAPTER 2. RESEARCH PROGRAM

Cooperation with respect to other projects

The IRTG provided me with the possibility to co-operate with partners not only within the experiment collaboration, but also further beyond to enable other groups to start using the new technologies. My main co-operation partners are from the following groups and institutions:

- ALICE TPC (Time Projection Chamber) and PHOS (Photon Spectrometer) groups, CERN
- Gesellschaft fuer Schwerionenforschung (GSI), Darmstadt
- Institut fuer Technische Informatik, Universitaet Mannheim (now part of the joint ZITI)
- Institutt for fysikk og teknologi, Universitetet i Bergen
- Kirchoff-Institut fuer Physik, Universitaet Heidelberg
- Oslo Cyclotron Laboratory, Fysikk institutt, Universitetet i Oslo
- PH-ED group, CERN
- Physikalisches Institut, Universitaet Heidelberg
- The Svedberg Laboratory, Uppsala

Study Program Attendance

I have attended all courses which were part of the IRTG:

- IRTG Workshop on *The Onset of deconfinement in nuclear collisions*, Bergen, April 2005
- IRTG Lecture Week on *Programmable hardware and hardware programming*, Heidelberg, Sept. 2005
- IRTG Lecture Week *Introduction to high energy particle and nuclear physics*, Oslo, March 2006
- IRTG Workshop on *Frontiers of Particle Identification*, Heidelberg, Oct. 2006
- IRTG Lecture Week on *Data acquisition and trigger systems*, Bergen, April 2007
- IRTG Workshop on *3D detectors*, Oslo, Sept. 2007

2.2. REPORTS OF THE STIPENDIARIES

Supervision in the IRTG

To me, the main benefits of being part of the IRTG were twofold. First, the constant exposure to other students working on more or less related subjects, but from other experiments, provided many incentives to keep looking beyond the scope of my own work, how the developments could help them. Additionally, the integration with students working on more physics-related subjects rather than electronics were helpful in understanding what my results would eventually be used for and what kind of research they would enable.

Secondly, I got into contact with many senior researchers and other stuff from the involved institutions which provided important guidance and advice on my own work.

In conclusion, I can only be grateful for the exchange platforms (seminars, lecture weeks) the IRTG has provided for us.

Stays abroad

In preparation for the PhD work and to acquire required knowledge about the underlying FPGA technology, I have been working as a research intern in the Xilinx Research Labs from December 2003 until April 2004. During my time with the IRTG itself, I only had short stays abroad of 1-2 weeks for performing the irradiation tests.

Publications

A selection of my talks and publications during the IRTG membership.

- IRTG seminar talk (application), *Improving on FPGA Radiation Tolerance* 2005-03-18
- IRTG seminar talk, *Basics of Dynamic Reconfiguration* 2005-07-15
- IRTG seminar talk, *Radiation Damage to Electronics* 2005-12-16

[[333](#), [334](#), [335](#), [336](#)]

Chapter 3

Study Program

A study program was initiated that served the needs of our very heterous group of students working at the interface of different communities most. As was realized early on, the problem for defining an interesting and integrating programm lies in the high specialisation within the different field that is mandatory to obtain a PhD. We therefore concentrated on specific 'add-on' lecture weeks that gave the chance to get a deeper insight into important techniques. This aspect developped into the most important and widely accepted IRTG - specific teaching activity as is also visible from the individual reports of the stipendees.

Lecture weeks

The basic idea is to combine basic lectures with hands-on experience for certain tasks and solve problems within small working groups. Thus learning fact is combined with the training of soft skills, since the different background of members of different groups have to be combined and the interaction among the members of the teams is absolutely necessary. This is clearly an experimental area in the education of doctoral students that from the experience that we obtained so far, is worth to be explored further. The different subjects that were addressed in this manner are the following:

Date	Location	Subject	Organizer
Sep. 2005	Heidelberg	VHDL design	Lindenstruth
Mar. 2006	Oslo	Basics of Particle Physics	Tveter
Oct. 2006	Heidelberg	Detector characterisation	Herrmann
Apr. 2007	Bergen	Data acquisition and trigger systems	Roehrich
Apr. 2008	Heidelberg	Physics at the LHC	Uwer

General education

On top of this taylored educational activities, lecture weeks and conferences were organised as detailed in the following section.

The IRTG also helped to shape and set the ground for the successful installation of the Heidelberg Graduate School for Fundamental Physics (HGSFP)

3.1. KEY SKILLS SEMINARS

that was funded as part of the excellence initiative in Germany. Several core concepts of the HGSFP were explored and initiated by the IRTG "Intelligent detectors" as:

- Heidelberg Graduate Days, a block course on a variety of physics or informatics topics that is offered regularly during the week preceeding the start of the lecture term.
- Soft skill seminars.

For the latter, although offered several times within the IRTG, the critical mass could never be reached within the limited size of the IRTG. Since the need for such an offer is obvious, Heidelberg and with it its partners in Bergen and Oslo have now (by the installation of the HGSFP) obtained a unique way to integrate this aspect into the PhD qualification.

Continuity

Since the admission process was partially delayed and not all positions were filled with new students on the starting date of the IRTG there is no problem with running the IRTG in a continuous fashion. Positions are offered on a regular basis on public media (web: job pilot and similar) but the success of this channel is very limited. Most of the accepted candidates came from direct contacts of the participating groups. The structure of these rather large participating experimental groups also serve as a fall back position for those (right now unfortunately many cases) where the PhD work could not be finished in time. As explained earlier this is caused to a large extent on the delay of the LHC start that was part of many of the PhD theses that developed detector components.

Since those students are still available and actively participating in the IRTG we actually are building up a lively and active group of young researchers that also helps to get new people more effectively started. In this process the IRTG plays an essential role in communicating startup difficulties and offers by the interaction among the PhD students solutions from experienced people.

3.1 Key skills seminars

As already described above specific soft skill seminars were not necessary within the IRTG. This part of the program has been shifted to the HGSFP. Key skills for a successful career in physics are, however, trained within the standard weekly or bi-weekly seminars of the IRTG. Presentations and discussions of the own work and the critical

There is also the offer to the student members of the IRTG to organize seminars by themselves. Up to now this part of the program has found only very limited acceptance. Practising organisational skills is clearly an aspect

CHAPTER 3. STUDY PROGRAM

that can and has to be improved. In the spirit of the IRTG this should, however, happen with relevant subjects and to the benefit of all members of the IRTG.

3.2 Activities

The specific activities within the IRTG are listed in appendix A. Also given there are the programs to the events.

3.3 Contacts to Abroad

Travel and visits of the students and scientist abroad supported by the IRTG are listed in appendix B

Chapter 4

Visiting scientist program

External scientists were invited to participate to the IRTG schools and conferences to which the IRTG participated:

- Heidelberg graduate days (see appendix A)
- John - Hopkins workshop KIP (see A)

Only lately a seminarblock was organized by the stipendiats, in Fall 2008 Dr. Aleo was giving lectures on the basics of heavy-ion physics.

Chapter 5

Organizational Structure

The organisational structure that has developed and is currently implemented is very flat. Each half year in the context of the schools or lecture weeks an international coordination meeting is held where all necessary decisions on the programmatic part are done. Members are all participating professors and the spokesperson of the stipendees.

Admission of new members into the IRTG is decided upon by all participating faculty members. Applicants are invited to a seminar and interview. Decisions have been always unanimous so far.

The daily administrative work is carried out by the secretary at the Physikalisches Institut (Heidelberg). The daily scientific coordination is shared by the IRTG postdoc and the speaker of the IRTG.

Chapter 6

Infrastructure

Support of the University of Heidelberg

The IRTG is supported in all aspects and needs that are caused by the presence of the additional manpower brought in by the program. The University is supplying

- office space for all members of the IRTG,
- laboratory space and equipment for the development tasks,
- coordination support in form of a secretary,
- administrative support to the students by university offices,
- recognition of the lectures and seminars as part of the teaching duties.

New offers are currently being implemented by the installation of the HGSFP. The IRTG "Development and Application of Intelligent Detectors" is intimately linked to the Heidelberg Graduate School of Fundamental Physics (HGSFP) that was founded in November 2006. The HGSFP took over major tasks that once were initiated within the IRTG and added more services to all our students.

- Organisation of the Heidelberg Graduate Days
- Organisation of soft skill seminars
- Help in administrative matters
- ...

All faculty members are members of the HGSFP as well and based on the experience gained within the IRTG helped to shape the definition of the structured educational program that is now implemented in the HGSFP. All doctoral students in physics are required to attend courses on the level

CHAPTER 6. INFRASTRUCTURE

of 4 hours per week that can be done as a block course during the Heidelberg Graduate Days. This course work is part of the final oral defense.

Scientifically the IRTG is embedded and co-working with many research programs, most notably:

- Integrated infrastructure initiative of the EU - 6. frameworkprogram:
I3HP - hadron physics
 - JRA 1 - Future dataacquisition
 - JRA 4 - Fast gaseous detectors
 - JRA 12 - Advanced TOF system
- Verbundforschung des BMBF
 - Programm Hadronen und Kerne
 - Programm Hochenergiephysik

As is described in the research section the research done in the framework of the IRTG is part of large international collaboration working at the major facilities worldwide:

- CERN
- GSI
- DESY
- SLAC

The work carried out by our PhD students and postdocs is part of the core program of those activities. Without the contributions of the members of our IRTG major goals of the various experiments would not be reachable.

Chapter 7

Interim Result

The IRTG "Development and Application of Intelligent Detectors" was successfully installed and is now reaching a high level of productivity. The tasks pursued within the PhD projects of the stipendees are of high scientific value and are well visible in the community. The IRTG is providing a network that allows to easily find experts at the interface of experimental particle and nuclear physics to information technologies. It also provides the means to mutually educate each other. This is especially important when planning new experiments.

Many new ideas have been implemented into the LHC experiments (ALICE, ATLAS, LHCb) that serve as a backbone of the scientific program pursued by the IRTG. The application of those concepts still needs to be seen and the scientific harvesting has not yet begun. Due to delays beyond our control this very important step has to be shifted to the next funding period.

This will be especially important since major new installations and experiments at the forefront of technologies need to be planned and designed. At FAIR in Darmstadt, a new facility is coming up. The IRTG has already now played a major role of building up the network to realize revolutionary ideas in the detection - data acquisition system. A high bandwidth data driven architecture is envisioned with many new problems to be solved. Similar questions arise for the program foreseen at the ILC.

The IRTG has demonstrated its integrating role in helping the participating communities to understand the different language and is well positioned to make similar contributions in the future. Its basic concept to combine experience from running experiments with the knowledge of cutting edge technology positions the participating universities at the center of scientific research.

Appendix A

Programs of IRTG activities

Activity tables

Veranstaltungen im Rahmen der IRTG

	Art	Zeit	wie oft	Inhalt	Zielgruppe	Leitung
2004						
	Sitzung	10/5/2004		Vorstellung Mitglieder		Prof. Herrmann
	13.Grad. Tage	11.10 – 14.10.2004				
	Sitzung	12/1/2004		Vorstellung Mitglieder		Prof. Herrmann
2005						
	Boardmeeting IRTG-Seminar	3/18/2005		Vorstellung Mitglieder		
			14 tägig			Prof. Herrmann
	14. Grad. Tage	04.04. - 08.04.2005		siehe Programm		
IRTG Bergen	Workshop	30.03. - 03.04.2005		siehe Programm		Prof. Röhrich
IRTG Heidelberg	Lecturweek	17.09. - 21.09.2005		VHDL design		Prof. Lindenstruth
	15. Grad Tage	10.10. - 14.10.2005		siehe Programm		

Veranstaltungen im Rahmen der IRTG

	Art	Zeit	wie oft	Inhalt	Zielgruppe	Leitung
2006						
	Seminar		14tägig			Prof. Herrmann
IRTG Oslo	school	05.03. - 10.03.2006				Prof. Skaali
	16. Graduat Days	18.04 - 21.04.2006		siehe Programm		
IRTG Heidelberg	school	03.10 – 08.10.2006				Prof. Herrmann
	17. Graduate Days	09.10 – 13.10.2006		siehe Programm		
2007						
	IRTG-Seminar		14 tägig			
	IRTG Seminar	2/26/2007				
	18. Grad. Tage	10.04. - 13.04.2007		siehe Programm		
IRTG Bergen	school	11.04. - 16.04.2007				Prof. Röhrich
	Seminar	26.09 – 28.09.2007			Students	Dr. Aleo
	19. Grad Days	08.10. - 12.10.2007		siehe Programm		

Activity programs

XIII. Heidelberger Graduiertenkurse Physik

11.–14. Oktober 2004

Raumverteilung der Kurse:

Vormittagskurse (9:30 – 12:30 Uhr):

<i>Referent(en)</i>	<i>Thema</i>	<i>Raum</i>
Massimo Bassan/ Claus Lämmerzahl	Newton's Apple revisited – Gravitation on Earth and in Space	Phil 12, SR
Dagmar Bruß	Quantum Information	Phil 12, gHS
Caren Hagner	Neutrino Physics	A-Ü-Str., Bib
Norman Sieroka	Philosophie der Symbole – die Entwicklung vom Elektromagnetismus zur Quantenfeldtheorie	Phil 19, SR
Achim Walter/Uwe Rascher/Stefan Terjung	Biophysik	Phil 12, kHS

Nachmittagskurse (14:00 – 17:00 Uhr):

<i>Referent(en)</i>	<i>Thema</i>	<i>Raum</i>
Laura Baudis	Dark Matter Searches	Phil 12, kHS
Hardo Bruhns	Kernfusion	Phil 12, gHS
Carlo Ewerz	Elementary Particle Physics – Concepts and Phenomena	Phil 12, SR
Reimer Kühn	Physik glasartiger Systeme	Phil 19, SR
Kilian Schwarz/Rüdiger Berlich	Grid Computing – Grundprinzipien und Anwendungen in datenintensiven Umgebungen	A-Ü-Str., SR I
Jörg Strotmann/Frank Müller	Physik der Sinne	A-Ü-Str., Bib

Kaffeepausen: Vor dem gHS, 1. Stock, Philosophenweg 12, sowie vor der Bibliothek, 3. Stock, Albert-Überle-Str. 3–5, und vor dem SR, Philosophenweg 19

Mittagessen: Vor dem/im „Neuen“ Hörsaal, Philosophenweg 12, im Plan auf der folgenden Seite: Nr. 10

Legende der Abkürzungen:

Phil 12, gHS:	Grosser Hörsaal,	1. Stock, Physikalisches Inst., Philosophenweg 12
Phil 12, kHS:	Kleiner Hörsaal,	2. Stock, Physikalisches Inst., Philosophenweg 12
Phil 12, SR:	Seminarraum,	3. Stock, Physikalisches Inst., Philosophenweg 12
Phil 19, SR:	Seminarraum,	EG, Inst. f. Theoretische Physik, Phil.weg 19
A-Ü-Str., Bib:	Bibliothek,	3. Stock, Physikalisches Inst., Albert-Überle Str. 3–5
A-Ü-Str., SR I:	Seminarraum I,	2. Stock, Physikalisches Inst., Albert-Überle Str. 3–5

Anmeldung zu den Graduiertenkursen:

Alle Teilnehmer werden gebeten, sich in der Zeit von 08:30 bis 09:30 Uhr am Montagmorgen bei Frau Krämer im **Tagungsbüro**, in der Albert-Überle Straße 3–5 (Physikalisches Institut, ehem. Angewandte Physik), im 1. Stock, Ostflügel, Raum 161, anzumelden, und ggf. ihren **Teilnehmerbeitrag** nachzuentrichten. Dort können Sie während der Kurse jederzeit weitere Informationen erhalten. Am Montag wird es außerdem während des Mittagessens eine kleine Begrüßung geben, bei der Sie alle weiteren Fragen an das Organisationsteam loswerden können.

Wir wünschen Ihnen bis dahin schon mal einen spannenden Vormittagskurs!

Der Montagabend soll im Institutsgarten bei einem (freien) Bier zumindest eingeläutet werden und danach, insbesondere bei schlechtem Wetter, in einem oder mehreren Lokalen den ersten Kurstag abrunden. Ankündigungen folgen!

Programm:

Montag, 11. Oktober

08:30 – 09:30	Anmeldung im Tagungsbüro, Albert-Überle Str. 3–5, 1. Stock
09:30 – 12:30	Vormittagskurse
12:30	Mittagessen & Begrüßung (am/im „Neuen“ Hörsaal, Phil 12)
14:00 – 17:00	Nachmittagskurse
17:00	Eingewöhnung in die Heidelberger Kneipenwelt bei Bier und Brezeln im Institutsgarten, Philosophenweg 12

Dienstag, 12. Oktober

09:30 – 12:30	Vormittagskurse
12:30	Mittagessen
14:00 – 17:00	Nachmittagskurse
17:00 –	zur freien Erkundung der Stadt

Mittwoch, 13. Oktober

09:30 – 12:30	Vormittagskurse
12:30	Mittagessen
14:00 – 17:00	Nachmittagskurse
18:00 – 19:30	Festkolloquium (Philosophenweg 12, gHS)
19:30	Grillfest im Garten des Instituts, Philosophenweg 12

Donnerstag, 14. Oktober

09:30 – 12:30	Vormittagskurse
12:30	Mittagessen
14:00 – 17:00	Nachmittagskurse

Herzlich eingeladen sind alle Interessierten am

Freitag, 15. Oktober und Samstag, 16. Oktober

10:30 – 18:00 (Sa.: 10:00 – 15:00)	Festveranstaltung anlässlich des 50. Geburtstages des CERN , Otto-Haxel Hörsaal und Nordfoyer des Kirchhoff-Instituts, Im Neuenheimer Feld 227, Siehe http://www.kip.uni-heidelberg.de/cern50/
--	---

XIII. Heidelberger Graduiertenkurse Physik

11. – 14. Oktober 2004

an der Fakultät für Physik der Universität Heidelberg

- **Massimo Bassan/Claus Lämmerzahl** *Università di Roma „Tor Vergata“/ZARM, Universität Bremen*
Newton's Apple revisited – Gravitation on Earth and in Space
- **Dagmar Bruß** *Universität Düsseldorf*
Quantum Information
- **Caren Hagner** *Universität Hamburg*
Neutrino Physics
- **Norman Sieroka** *Eidgenössische Technische Hochschule, Zürich*
Philosophie der Symbole – Die Entwicklung vom Elektromagnetismus zur Quantenfeldtheorie
- **Achim Walter, Uwe Rascher/Stefan Terjung** *Forschungszentr. Jülich/EMBL Heidelberg*
Biophysik

- **Laura Baudis** *University of Florida, U.S.A.*
Dark Matter Searches
- **Hardo Bruhns** *Europäische Kommission, Brüssel*
Kernfusion
- **Carlo Ewerz** *Università di Milano*
Elementary Particle Physics – Concepts and Phenomena
- **Reimer Kühn** *King's College, London, UK*
Physik glasartiger Systeme
- **Kilian Schwarz/Rüdiger Berlich** *Gesellschaft für Schwerionenforschung, Darmstadt/Forschungszentrum Karlsruhe*
GRID computing – Grundprinzipien und Anwendung in datenintensiven Umgebungen
- **Jörg Strotmann/Frank Müller** *Universität Hohenheim/Forschungszentrum Jülich*
Physik der Sinne

Festkolloquium (Mittwoch, 13. Oktober '04, 18:00 Uhr, gHS Phil. 12):

Ciphers, quanta and computers
Information processing in quantum-mechanical systems

Artur Ekert

Centre for Quantum Computation, DAMTP, University of Cambridge, GB

Die XIII. Heidelberger Graduiertenkurse Physik werden unterstützt von:



Deutsche
Forschungsgemeinschaft

DFG



MLP

XIV. Heidelberger Graduiertenkurse Physik

4.–8. April 2005

Raumverteilung der Kurse:

Vormittagskurse (9:30 – 12:30 Uhr):

<i>Referent(en)</i>	<i>Thema</i>	<i>Raum</i>
Christoph Clauser, Andreas Hartmann, Darius Mottaghy, Roland Wagner	Geothermische Energie – Physikalische Grundlagen und Nutzungsmöglichkeiten	Phil 19, SR beginnt am Dienstag, 5. April!
Tatsuya Nakada	CP violation and flavour physics: The Quest for Matter–Antimatter Asymmetry	Phil 12, gHS
Peter Schmelcher	Modern Problems in Atomic Physics	Phil 12, kHS
Bernhard Schmidt	Introduction to Mathematica	A–Ü–Str., Bib
Werner M. Tscharnuter	Hydrodynamische Wellenphänomene	A–Ü–Str., SR I

Nachmittagskurse (14:00 – 17:00 Uhr):

<i>Referent(en)</i>	<i>Thema</i>	<i>Raum</i>
Henk Eskes, Hennie Kelder, Pieter Levelt, Ulrich Platt, Klaus Pfeilsticker	Physics of the Atmosphere	A–Ü–Str., Bib 13:00 – 16:00 hrs!
Holger Gies, Jan Martin Pawlowski	Confinementbilder	Phil 19, SR
Ullrich A. Glasmacher	Physikalisch–Naturwissenschaftliche Methoden der Altersbestimmung in der Archäometrie	A–Ü–Str., SR I
Dieter Heermann	Modellierung biophysikalischer Systeme	Phil 12, SR
Torsten Huisinga, Tobias Kretz, Andreas Schadschneider, Michael Schreckenberg	Physik des Verkehrs	Phil 12, gHS
Hanno Scharf	Image Processing	Phil 12, kHS

Kaffeepausen: Vor dem gHS, 1. Stock, Philosophenweg 12, sowie vor der Bibliothek, 3. Stock, Albert–Überle–Str. 3–5, und vor dem SR, Philosophenweg 19

Mittagessen: Vor dem/im „Neuen“ Hörsaal, Philosophenweg 12, im Plan auf der folgenden Seite: Nr. 10

Legende der Abkürzungen:

Phil 12, gHS:	Grosser Hörsaal,	1. Stock, Physikalisches Inst., Philosophenweg 12
Phil 12, kHS:	Kleiner Hörsaal,	2. Stock, Physikalisches Inst., Philosophenweg 12
Phil 12, SR:	Seminarraum,	3. Stock, Physikalisches Inst., Philosophenweg 12
Phil 19, SR:	Seminarraum,	EG, Inst. f. Theoretische Physik, Phil.weg 19
A–Ü–Str., Bib:	Bibliothek,	3. Stock, Physikalisches Inst., Albert–Überle Str. 3–5
A–Ü–Str., SR I:	Seminarraum I,	2. Stock, Physikalisches Inst., Albert–Überle Str. 3–5

Anmeldung zu den Graduiertenkursen:

Alle Teilnehmer werden gebeten, sich in der Zeit von 08:30 bis 09:30 Uhr am Montagmorgen bei Frau Krämer (Tel. +49 (0)6221 549 212) im **Tagungsbüro**, in der Albert-Überle Straße 3–5 (Physikalisches Institut, ehem. Angewandte Physik), im 1. Stock, Ostflügel, Raum 161, anzumelden, und ggf. ihren **Teilnehmerbeitrag** nachzuentrichten. Dort können Sie während der Kurse jederzeit weitere Informationen erhalten. Am Montag wird es außerdem während des Mittagessens eine kleine Begrüßung geben, bei der Sie alle weiteren Fragen an das Organisationsteam loswerden können. Wir wünschen Ihnen bis dahin schon mal einen spannenden Vormittagskurs! Der Montagabend soll im Institutsgarten, nach dem Sonderkolloquium (s. Programm), bei (Frei-) Bier & Brezeln eingeläutet werden!

Programm:

Montag, 4. April

08:30 – 09:30	Anmeldung im Tagungsbüro, Albert-Überle Str. 3–5, 1. Stock
09:30 – 12:30	Vormittagskurse
12:30	Mittagessen & Begrüßung (am/im „Neuen“ Hörsaal, Phil 12)
14:00 – 17:00*	Nachmittagskurse
17:30 – 18:30	Sonderkolloquium (Philosophenweg 12, gHS): Peter Landshoff (Cambridge–MIT Institute): <i>Business and Academia need to work together</i> – <i>from High Energy Physics to Science Management</i>
18:30	Bier & Brezeln im Institutsgarten, Philosophenweg 12

Dienstag, 5. April

09:30 – 12:30	Vormittagskurse
12:30	Mittagessen
14:00 – 17:00*	Nachmittagskurse

Mittwoch, 6. April

09:30 – 12:30	Vormittagskurse
12:30	Mittagessen
14:00 – 17:00*	Nachmittagskurse
18:00 – 19:30	Festkolloquium (Philosophenweg 12, gHS) Gerard Meijer (Fritz-Haber-Institut, Berlin): <i>Cool Molecules</i>
19:30	Grillfest im Garten des Instituts, Philosophenweg 12

Donnerstag, 7. April

09:30 – 12:30	Vormittagskurse
12:30	Mittagessen
14:00 – 17:00*	Nachmittagskurse

Freitag, 8. April

09:30 – 12:30	Vormittagskurse
12:30	Mittagessen
14:00 – 17:00*	Nachmittagskurse

*) Ausnahme: Physics of the Atmosphere: Zeit: 13:00 – 16:00 Uhr

XIV. Heidelberger Graduiertenkurse Physik

4. – 8. April 2005

an der Fakultät für Physik der Universität Heidelberg

- **Geothermische Energie – Physikalische Grundlagen und Nutzungsmöglichkeiten** *Christoph Clauser, Andreas Hartmann, Darius Mottaghy, Roland Wagner*
Rheinisch-Westfälische Technische Hochschule Aachen
- **B-Physics: The Quest for Matter-Antimatter Asymmetry** *Tatsuya Nakada*
CERN, Genf
- **Modern Problems in Atomic Physics** *Peter Schmelcher*
Universität Heidelberg
- **Introduction to Mathematica** *Bernhard Schmidt*
DESY, Hamburg
- **Hydrodynamische Wellenphänomene** *Werner M. Tscharnuter*
Universität Heidelberg

Nachmittagskurse (Mo.–Fr., 14:00–17:00 Uhr):

- **Physics of the Atmosphere** *Henk Eskes, Hennie Kelder, Pietermel Levelt/
Ulrich Platt, Klaus Pfeilsticker*
(13:00–16:00 Uhr!)
Koninklijk Nederlands Meteorologisch Instituut, De Bilt, NL/Universität Heidelberg
- **Confinementbilder** *Holger Gies, Jan Martin Pawlowski*
Universität Heidelberg
- **Physikalisch-Naturwissenschaftliche Methoden der Altersbestimmung in der Archäometrie** *Ullrich A. Glasmacher*
Universität Heidelberg
- **Modellierung biophysikalischer Systeme** *Dieter Heermann*
Universität Heidelberg
- **Physik des Verkehrs** *Torsten Huisinga, Tobias Kretz, Andreas Schadschneider,
Michael Schreckenberg*
Universität Duisburg–Essen
- **Image Processing** *Hanno Schar*
Forschungszentrum Jülich

Festkolloquium (Mittwoch, 6. April, 18:00 Uhr, gHS Phil. 12):

Cool Molecules

Gerard Meijer

Fritz Haber Institut, Berlin

Die XIV. Heidelberger Graduiertenkurse Physik werden unterstützt von:



Deutsche
Forschungsgemeinschaft
DFG



MLP

**2nd International Workshop on
the Critical Point and Onset of Deconfinement**
30 March - 3 April 2005

**Topical Workshop: Advanced Instrumentation for
Future Accelerator Experiments***
3 April - 6 April 2005

Bergen, Norway

Organizing Committee

L.V. Bravina
L.P. Csernai
J.J. Gaardhøje
H.-Å. Gustafsson
H. Helstrup
P. Houvinen
G. Løvhøiden
J. Nystrand
D. Röhrich
T.S. Tvetter

PHYSICS

- Onset of Deconfinement
- The Critical Point
- Particle Production
- Event-by-event Fluctuations
- Energy and System-size dependence

INSTRUMENTATION

- Future Nuclear and Particle Physics Experiments
- Detector Electronics and Data Acquisition Development

**International Advisory
Committee**
M. Gazdzicki
P. Seyboth
E. Shuryak

<http://www.ift.uib.no/criticalpoint>

*Organized by the International Research Training Group "Intelligent Detectors"



Deutsche
Forschungsgemeinschaft
DFG



Main Page

From GraKo-VHDL

Heidelberger VHDL Graduate Courses

The Heidelberg VHDL graduate course aims at students of the Heidelberg/Mannheim/Bergen/Oslo international research and training group and other interested students. It teaches the fundamentals of hardware design and VLSI design, using the hardware design language VHDL as example. The course is split into lectures and practical work, where the material, which is taught in the morning is practised immediately in the afternoon. Here own designs are developed, translated into hardware, using the appropriate tools and then exercised using the FPGA evaluation board UXIBO (<http://sus.ti.uni-mannheim.de/Uxibo>), which was developed in Mannheim. The lectures will take place in the KIP CIP Pool (<http://www.kip.uni-heidelberg.de/cip/cip.html>) and the practical work in the KIP hardware praktikum (<http://www.kip.uni-heidelberg.de/ti/HWP/?lang=en>). We will try to provide students, who already have knowledge of VHDL, with appropriate advanced study and praktikum material.

The Course is organized during five days with the program below. All relevant Course material, reference designs, assignments can be found there. The lectures start at 9:00 in the morning and the practical course ends at 17:00 in the afternoon.

Introduction to VHDL and Synthesis

Saturday, September 17

Lectures

Introduction, Motivation

Hardware Design Layers

Examples of Target Technologies

Building blocks of digital circuits

Introduction to VHDL

VHDL signals and data types

VHDL operators

Exercises

Introduction

First designs in FPGA

Social Event

Sunday, September 18

- Meeting 10:00 at the Kirchhoff Institute for Physics where a bus will take us first to Speyer.
- Visit of the famous "Dom zu Speyer" which is the largest existing Roman church in the world.
- "Technikmuseum Sinsheim" where you can have a closer look at more than 300 vintage cars, 200 Motorbikes, 40 Sportcars, the largest collection of Formular-1 cars, 60 planes and a walk through a CONCORDE or a TUPOLEV TU-144.
- At 16:30 the bus will bring us back to Heidelberg, giving the Germans the possibility to go to the election and vote for a (even) better future.
- After so much hard work there definitely the need for a relaxed barbecue in the garden of the Physikalisches Institut. 19:00! Don't miss it!!!
- !!! CHANGE !!! Due to the weather forecast the barbeque will take place in the old library in the Albert Überle Straße. And it will start at 18:30!!!
- More detailed information will be given on Saturday during the VHDL course

Parallel and sequential Operators

Monday, September 19

Lectures

Parallel and sequential Operators Introduction and fundamentals

Parallel and sequential Operators Advanced features

Exercises

Parallel and sequential Operator designs

Finite State Machines in VHDL

Tuesday, September 20

Lectures

Finite State Machines in VHDL

Exercises

FSM Designs

VHDL synthesis and application of FPGAs

Wednesday, September 21

Lectures

VHDL synthesis

VHDL FPGA Designs

Commercial Applications of FPGAs

Exercises

Advanced FPGA Designs in VHDL

Miscellaneous

Miscellaneous Material

Retrieved from "http://www.kip.uni-heidelberg.de/wiki/GraKo-VHDL-Einfuehrungskurs/index.php/Main_Page"

-
- This page was last modified 12:45, 16 Sep 2005.

XV. Heidelberger Graduiertenkurse Physik

10.-14. Oktober 2005

Raumverteilung der Kurse:

Vormittagskurse (9:30 - 12:30 Uhr):

<i>Referent(en)</i>	<i>Thema</i>	<i>Raum</i>
Hans Günter Dosch	Physik des Hörens	Phil 19, SR
Jürgen Gross	Schreiben, Publizieren, Präsentieren	Phil 12, SR
Michael Dittmar	Energie und Umwelt	Phil 12, gHS
Helmuth Spieler	Radiation detectors	Phil 12, kHS
Luca Amendola	Dark energy	A-Ü-Str., Bib
Devaraj van der Meer	Granular Matter	A-Ü-Str., SR I

Nachmittagskurse (14:00 - 17:00 Uhr):

<i>Referent(en)</i>	<i>Thema</i>	<i>Raum</i>
Hardo Bruhns	Plasmaphysik	A-Ü-Str., Bib
Helge Kragh	Historical Aspects	Phil 19, SR
Johannes L'huillier	Nichtlineare Optik	Phil 12, SR
Kees Dullemond	Entstehung von Sternen	Phil 12, gHS
Eckhard Elsen	Teilchenbeschleuniger	Phil 12, kHS

Kaffeepausen: Vor dem gHS, 1. Stock, Philosophenweg 12, sowie vor der Bibliothek, 3. Stock, Albert-Überle-Str. 3-5, und vor dem SR, Philosophenweg 19

Mittagessen: Vor dem/im „Neuen“ Hörsaal, Philosophenweg 12, im Plan auf der folgenden Seite: Nr. 10

Legende der Abkürzungen:

Phil 12, gHS:	Grosser Hörsaal,	1. Stock, Physikalisches Inst., Philosophenweg 12
Phil 12, kHS:	Kleiner Hörsaal,	2. Stock, Physikalisches Inst., Philosophenweg 12
Phil 12, SR:	Seminarraum,	3. Stock, Physikalisches Inst., Philosophenweg 12
Phil 19, SR:	Seminarraum,	EG, Inst. f. Theoretische Physik, Phil.weg 19
A-Ü-Str., Bib:	Bibliothek,	3. Stock, Physikalisches Inst., Albert-Überle Str. 3-5
A-Ü-Str., SR I:	Seminarraum I,	2. Stock, Physikalisches Inst., Albert-Überle Str. 3-5

Anmeldung zu den Graduiertenkursen:

Alle Teilnehmer werden gebeten, sich in der Zeit von 08:30 bis 09:30 Uhr am Montagmorgen bei Frau Krämer (Tel. +49 (0)6221 549 212) im **Tagungsbüro**, in der Albert-Überle Straße 3-5 (Physikalisches Institut, ehem. Angewandte Physik), im 1. Stock, Ostflügel, Raum 161, anzumelden, und ggf. ihren **Teilnehmerbeitrag** nachzuentrichten. Dort können Sie während der Kurse jederzeit weitere Informationen erhalten. Am Montag wird es außerdem während des Mittagessens eine kleine Begrüßung geben, bei der Sie alle weiteren Fragen an das Organisationsteam loswerden können. Wir wünschen Ihnen bis dahin schon mal einen spannenden Vormittagskurs!

Programm:

Montag, 10. Oktober

08:30 - 09:30	Anmeldung im Tagungsbüro, Albert-Überle Str. 3-5, 1. Stock
09:30 - 12:30	Vormittagskurse
12:30	Mittagessen & Begrüßung (am/im „Neuen“ Hörsaal, Phil 12)
14:00 - 17:00	Nachmittagskurse
17:30	Bier und Brezeln

Dienstag, 11. Oktober

09:30 - 12:30	Vormittagskurse
12:30	Mittagessen
14:00 - 17:00	Nachmittagskurse

Mittwoch, 12. Oktober

09:30 - 12:30	Vormittagskurse
12:30	Mittagessen
14:00 - 17:00	Nachmittagskurse
18:00 - 19:30	Festkolloquium (Philosophenweg 12, gHS) Peter Fromherz, Max-Planck-Institut für Biochemie, München: Halbleiter mit Hirn
19:30	Grillfest im Garten des Instituts, Philosophenweg 12

Donnerstag, 13. Oktober

09:30 - 12:30	Vormittagskurse
12:30	Mittagessen
14:00 - 17:00	Nachmittagskurse

Freitag, 14. Oktober

09:30 - 12:30	Vormittagskurse
12:30	Mittagessen
14:00 - 17:00	Nachmittagskurse

IRTG Lecture Week in Oslo 6.-10. March, 2006

PROGRAM

Monday		
13:00-13:15	Opening of the Lecture Week	
13:15-17:00	Introduction to the Standard Model	Gerald Eigen
Tuesday		
09:00-11:00	Structure functions – from HERA to LHC	Hans-Christian Schultz-Coulon
11:00-13:00	Flow in heavy-ion collisions	Eugen Zabrodin
13:00-14:00	Lunch	
14:00-17:00	Student presentations	
Wednesday		
09:00-10:00	Heavy-ion perspectives RHIC-LHC (Part I)	Joakim Nystrand
10:00-12:00	LHC initial physics	Anna Lipniacka
12:00-13:00	Lunch	
13:00-17:00	Excursion	
17:00	Back on campus	
Thursday		
09:00-10:00	Heavy-ion perspectives RHIC-LHC (Part II)	Joakim Nystrand
10:00-13:00	CP violation – a key to understanding the evolution of the universe?	Gerald Eigen
13:00-14:00	Lunch	
14:00-17:00	Student presentations	
18:30	Conference dinner	

Friday		
09:00-12:00	<ol style="list-style-type: none"> 1. Parton structure of nucleons and hard inclusive processes in QCD 2. Hard phenomena – from protons to nuclei 3. Ultrapерipheral collisions at LHC – a new testing ground of QCD 	Mark Strikman
12:00-13:00	Statistical model predictions for p+p and Pb+Pb at LHC	Ingrid Kraus
13:00	Lunch	

XVI. Heidelberger Graduiertenkurse Physik

18. - 21. April 2006

Raumverteilung der Kurse:

Vormittagskurse (9:30 - 12:30 Uhr):

<i>Referent(en)</i>	<i>Thema</i>	<i>Raum</i>
Sergei Winitzki	Quantum fields in Curved Spacetime	Phil 12, kHS
Michael Schmelling	Data Analysis	Phil 12, gHS
Stephanus Büttgenbach	Mikrosystemtechnik	Phil 12, SR
Wolfgang Schlegel (u.v.m.)	Hadronentherapie	A-Ü-Str., Bib
Hans-Peter Deutsch, Reinhard Hirsch, Jürgen Stein	Finanzmathematik	Phil 19, SR

Nachmittagskurse (14:00 - 17:00 Uhr):

<i>Referent(en)</i>	<i>Thema</i>	<i>Raum</i>
Immo Appenzeller	Die ersten Galaxien: Wie unser heutiger Kosmos entstand	A-Ü-Str., Bib
Wolfgang Send	Physik des Fliegens	Phil 12, gHS
Christian Enss	Physik am absoluten Nullpunkt	Phil 12, SR
Jörg Jäckel	Axione und ihre Verwandten: von der Theorie zum Experiment.	Phil 12, kHS
H.-P. Deutsch, R. Hirsch, J. Stein	Finanzmathematik	Phil 19, SR

Kaffeepausen: Vor dem gHS, 1. Stock, Philosophenweg 12, sowie vor der Bibliothek, 3. Stock, Albert-Überle-Str. 3-5, und vor dem SR, Philosophenweg 19

Mittagessen: Vor dem/im „Neuen“ Hörsaal, Philosophenweg 12, im Plan auf der folgenden Seite: Nr. 10

Legende der Abkürzungen:

Phil 12, gHS:	Grosser Hörsaal,	1. Stock, Physikalisches Inst., Philosophenweg 12
Phil 12, kHS:	Kleiner Hörsaal,	2. Stock, Physikalisches Inst., Philosophenweg 12
Phil 12, SR:	Seminarraum,	3. Stock, Physikalisches Inst., Philosophenweg 12
Phil 19, SR:	Seminarraum,	EG, Inst. f. Theoretische Physik, Phil.weg 19
A-Ü-Str., Bib:	Bibliothek,	3. Stock, Physikalisches Inst., Albert-Überle Str. 3-5
A-Ü-Str., SR I:	Seminarraum I,	2. Stock, Physikalisches Inst., Albert-Überle Str. 3-5

Anmeldung zu den Graduiertenkursen:

Alle Teilnehmer werden gebeten, sich in der Zeit von 08:30 bis 09:30 Uhr am Dienstagmorgen bei Frau Krämer (Tel. +49 (0)6221 549 212) im **Tagungsbüro**, in der Albert-Überle Straße 3-5 (Physikalisches Institut, ehem. Angewandte Physik), im 1. Stock, Ostflügel, Raum 161, anzumelden, und ggf. ihren **Teilnehmerbeitrag** nachzuentrichten. Dort können Sie während der Kurse jederzeit weitere Informationen erhalten. Am Montag wird es außerdem während des Mittagessens eine kleine Begrüßung geben, bei der Sie alle weiteren Fragen an das Organisationsteam loswerden können. Wir wünschen Ihnen bis dahin schon mal einen spannenden Vormittagskurs!

Programm:

Dienstag, 18. April

08:30 - 09:30	Anmeldung im Tagungsbüro, Albert-Überle Str. 3-5, 1. Stock
09:30 - 12:30	Vormittagskurse
12:30	Mittagessen & Begrüßung (am/im „Neuen“ Hörsaal, Phil 12)
14:00 - 17:00	Nachmittagskurse
17:30	Bier und Brezeln

Mittwoch, 19. April

09:30 - 12:30	Vormittagskurse
12:30	Mittagessen
14:00 - 17:00	Nachmittagskurse

Donnerstag, 20. April

09:30 - 12:30	Vormittagskurse
12:30	Mittagessen
14:00 - 17:00	Nachmittagskurse
18:00 - 19:30	Festkolloquium (Philosophenweg 12, gHS) Immanuel Bloch, Universität Mainz
19:30	Grillfest im Garten des Instituts, Philosophenweg 12

Freitag, 21. April

09:30 - 12:30	Vormittagskurse
12:30	Mittagessen
14:00 - 17:00	Nachmittagskurse

APPENDIX A. PROGRAMS OF IRTG ACTIVITIES

		gHS		SR, Phil. 19		SR, Phil. 19		kHS			
		Wednesday	Thursday	Friday	Saturday	Sunday					
		4. October	5. October	6. October	7. October	8. October					
		Introduction Herrmann		Silicon Det. I Svensson		Silicon Det. II Fischer		Calorim. I Poeschl		<i>Excursion</i>	
		Coffee Break		Coffee Break		Coffee Break		Coffee Break			
		Gas Det. I Uwer		TOF Det. Schüttauf		Gas Det. II Andronic		Calorim. II Reiter			
		Lunch		Lunch		Lunch		Lunch			
		Practical Exercises		Practical Exercises		Practical Exercises		Reporting of Results			
		Practical Exercises		Practical Exercises		Practical Exercises		Practical Exercises			
		Coordination Meeting				Dinner					
		3. October									
		<i>Arrival</i>									
		9 ⁰⁰ - 9 ³⁰									
		9 ⁰⁰ - 10 ³⁰ 45									
		11 ⁰⁰ - 12 ³⁰									
		14 ⁰⁰ - 16 ⁰⁰									
		16 ⁰⁰ - 18 ⁰⁰									
		19 ³⁰ - ???									
		Morning		Afternoon		Evening					

XVII. Heidelberger Graduiertenkurse Physik

9. - 13. Oktober 2006

Raumverteilung der Kurse:

Vormittagskurse (9:30 - 12:30 Uhr):

<i>Referent(en)</i>	<i>Thema</i>	<i>Raum</i>
Kai Bongs	Präzisionsmessungen in der Quantenphysik	Phil 12, kl. HS
Dirk Dubbers	Phase transitions	Phil 12, gr. HS
Joachim Lammarsch	Java 5	A-Ü-Str., CIP-Pool
Massimo Meneghetti	Gravitational Lensing	A-Ü-Str., Bibliothek

Nachmittagskurse (14:00 - 17:00 Uhr):

<i>Referent(en)</i>	<i>Thema</i>	<i>Raum</i>
Oleg Borisov	Statistical Physics of Macromolecules	Phil 12, SR
Frank Steffen	Dark Matter	Phil 12, gr. HS
Ernst Sichtermann	Spin in Nuclear and Particle Physics	A-Ü-Str., Bibliothek
Tobias Hirsch, Martin Pehnt, Daniel Kray, Uli Würfel, Birger Zimmermann	Energie der Zukunft	Phil 12, kl. HS

Kaffeepausen: Vor dem gr. HS, 1. Stock, Philosophenweg 12, sowie vor der Bibliothek, 3. Stock, Albert-Überle-Str. 3-5

Mittagessen: Im „Neuen“ Hörsaal, Philosophenweg 12, im Plan auf der folgenden Seite: Nr. 10

Legende der Abkürzungen:

Phil 12, gr. HS:	Grosser Hörsaal,	1. Stock, Physikalisches Inst., Philosophenweg 12
Phil 12, kl. HS:	Kleiner Hörsaal,	2. Stock, Physikalisches Inst., Philosophenweg 12
Phil 12, SR:	Seminarraum,	3. Stock, Physikalisches Inst., Philosophenweg 12
A-Ü-Str., Bib:	Bibliothek,	3. Stock, Physikalisches Inst., Albert-Überle Str. 3-5
A-Ü-Str., CIP-Pool:	Computer-Raum,	2. Stock, Physikalisches Inst., Albert-Überle Str. 3-5

Anmeldung zu den Graduiertenkursen:

Alle Teilnehmer werden gebeten, sich in der Zeit von 08:30 bis 09:30 Uhr am Montagmorgen bei Frau Krämer (Tel. +49 (0)6221 549 212) im **Tagungsbüro**, in der Albert-Überle-Straße 3-5 (Physikalisches Institut, ehem. Angewandte Physik), im 1. Stock, Ostflügel, Raum 161, anzumelden, und ggf. ihren **Teilnehmerbeitrag** nachzuentrichten. Dort können Sie während der Kurse jederzeit weitere Informationen erhalten. Am Montag wird es außerdem während des Mittagessens eine kleine Begrüßung geben, bei der Sie alle weiteren Fragen an das Organisationsteam loswerden können. Wir wünschen Ihnen bis dahin schon mal einen spannenden Vormittagskurs!

Programm:

Montag, 9. Oktober

08:30 - 09:30 Anmeldung im Tagungsbüro, Albert-Überle Str. 3-5, 1. Stock
09:30 - 12:30 Vormittagskurse
12:30 Mittagessen & Begrüßung (im „Neuen“ Hörsaal, Phil 12)
14:00 - 17:00 Nachmittagskurse
17:30 Bier und Brezeln

Dienstag, 10. Oktober

09:30 - 12:30 Vormittagskurse
12:30 Mittagessen
14:00 - 17:00 Nachmittagskurse

Mittwoch, 11. Oktober

09:30 - 12:30 Vormittagskurse
12:30 Mittagessen
14:00 - 17:00 Nachmittagskurse

Donnerstag, 12. Oktober

09:30 - 12:30 Vormittagskurse
12:30 Mittagessen
14:00 - 17:00 Nachmittagskurse
17:30 - 19:00 **Festkolloquium** (Philosophenweg 12, gr. HS)
19:00 d-fine Grillfest im Garten des Instituts, Philosophenweg 12

Freitag, 13. Oktober

09:30 - 12:30 Vormittagskurse
12:30 Mittagessen
14:00 - 17:00 Nachmittagskurse

XVIII. HEIDELBERG PHYSICS GRADUATE DAYS

Tue 10 – Fri 13 April 2007

Registration

All participants are requested to come on Tuesday morning between 8:30 and 9:30 a.m. to the conference office, Albert-Überle-Str. 3-5, 1st floor, room 161 to Mrs. Krämer (Tel. +49 6221 54 9212). If you did not transfer the fee, you should pay it cash there. In the office you can get further information about the event. There will also be a short welcome address by the organisers on Tuesday during the lunch, where you can ask further questions.

Morning Courses (9:30 – 12:30)

Thomas Schücker	Noncommutative Geometry	Phil 12 gHS
Holger Gies, Jörg Jäckel	PVLAS Experiment	Phil12 SR
Selim Jochim, Henning Moritz	Creating new states of matter: Experiments with ultra-cold Fermi gases	Phil 12 kHS
Marion u. Joachim Lammarsch	Publizieren und Präsentieren mit LaTeX	A-Ü 3-5 CIP-Pool
Rüdiger Schmidt, Hans-Christian Schultz-Coulon, Ulrich Uwer, Raimond Snellings	LHC: Physics, Machine, Experiments	A-Ü 3-5 Bib

Afternoon Courses (14:00 – 17:00)

Roman Pöschl	Calorimeters in High Energy and Nuclear Physics	A-Ü 3-5 SR1
Gerald Dunne	Effective actions	Phil 12 gHS
Rachel Bean	Cosmic Microwave Background	Phil 12 kHS
Ulrich Finke	Atmosphärische Elektrizität	Phil 12 SR
Christian Gutt	Einführung in die Physik der Röntgenstreuung	A-Ü 3-5 Bib

Festvortrag – Hans Jensen Lecture (Tue 12.04.2007, 17:30)

Hanns Ruder	Dunkle Materie, Dunkle Energie (finstere Gedanken) – Moderne Entwicklungen in der Kosmologie	Phil 12 gHS
-------------	---	-------------

Legend

Phil 12 gHS: Grosser Hörsaal, 1st floor, Physikalisches Institut, Philosophenweg 12
Phil 12 kHS: Kleiner Hörsaal, 2nd floor, Physikalisches Institut, Philosophenweg 12
Phil 12 SR: Seminarraum, 3rd floor, Physikalisches Institut, Philosophenweg 12
A-Ü 3-5 Bib: ehemalige Bibliothek, 3rd floor, Physikalisches Institut, Albert-Überle-Str. 3-5
A-Ü 3-5 CIP-Pool: Computer room, 2nd floor, Physikalisches Institut, Albert-Überle-Str. 3-5

Coffee breaks (around 11:00 and 15:30)

in front of gHS, 1st floor, Philosophenweg 12, and
in front of Bibliothek, 3rd floor, Albert-Überle-Str. 3-5

Lunch (12:30 – 14:00)

in „Neuer Hörsaal“, Philosophenweg 12 (building #10 on the map)

Schedule

Tuesday, April 10

- 8:30 – 9:30 Registration in Albert-Überle-Str. 3-5, 1st floor, room 161
- 9:30 – 12:30 Morning lectures
- 12:30 – 14:00 Lunch, welcome address
- 14:00 – 17:00 Afternoon lectures
- 17:30 – ... Welcome party with beer and pretzels

Wednesday, April 11

- 9:30 – 12:30 Morning lectures
- 12:30 – 14:00 Lunch
- 14:00 – 17:00 Afternoon lectures

Thursday, April 12

- 9:30 – 12:30 Morning lectures
- 12:30 – 14:00 Lunch
- 14:00 – 17:00 Afternoon lectures
- 17:30 – 19:00 Celebratory colloquium in Philosopheweg 12, Großer Hörsaal
- 19:30 – ... d-fine barbecue

Friday, April 13

- 9:30 – 12:30 Morning lectures
- 12:30 – 14:00 Lunch
- 14:00 – 17:00 Afternoon lectures

Map

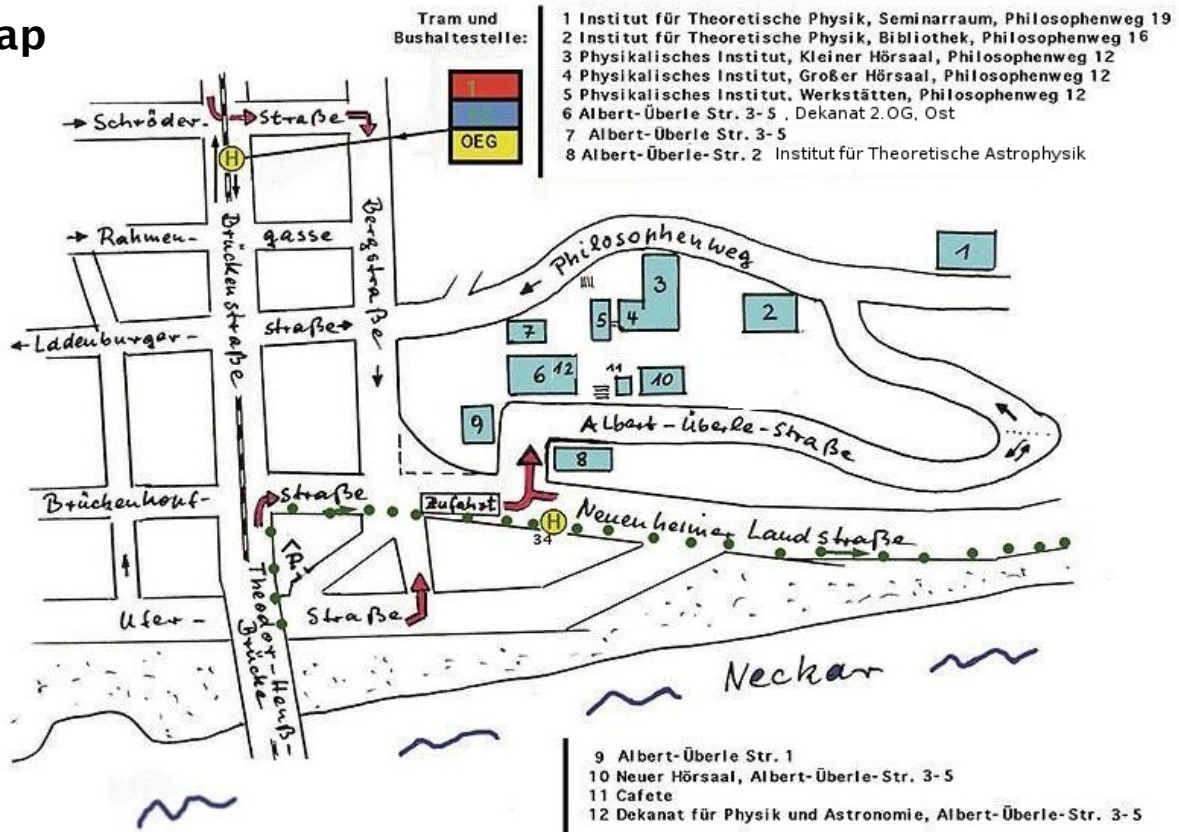

Program

[\[Thursday, Aug 2\]](#) [\[Friday, Aug 3\]](#) [\[Saturday, Aug 4\]](#)

Thursday, August 2

8:30-9:30	<i>Registration</i>	
9:30-9:35	O. Nachtmann (Heidelberg)	<i>Opening</i>
9:35-10:15	S. Moch (DESY-Zeuthen)	Hard QCD at hadron colliders
10:20-11:00	Ch. Royon (CEA Saclay)	QCD and jets at the Tevatron and the LHC
11:00-11:30	<i>Coffee break</i>	
11:30-12:10	C. Ewerz (ECT Trento)	From soft QCD to string theory
12:15-12:55	A. D. Martin (Durham)	Diffractive Higgs production at the LHC
13:00-14:30	<i>Lunch</i>	
14:30-15:10	M. Grothe (Torino/Wisconsin)	Soft physics at the LHC - diffractive Higgs searches
15:15-15:55	R. Barbieri (SNS Pisa)	Standard and non standard ideas for the Higgs sector
16:00-16:30	<i>Coffee break</i>	
16:30-17:10	R. Cousins (UCLA)	Higgs searches at the LHC
17:15-17:55	K. Meier (Heidelberg)	Status report of the ILC project
18:30	<i>Bus transfer to Philosophenweg 12</i>	
19:00	<i>Welcome Buffet</i>	

Friday, August 3

9:00-9:40	H. Lacker (Dresden)	Flavour physics at the LHC
9:45-10:25	W. Bernreuther (RWTH Aachen)	Top quark physics at the LHC (theory)

10:30-11:00	<i>Coffee break</i>	
11:00-11:40	A. Quadt (Göttingen)	<u>Top quark physics at the LHC (experiment)</u>
11:45-12:25	E. Shuryak (SUNY)	<u>The theory of the quark gluon plasma, from RHIC to LHC</u>
12:30-14:00	<i>Lunch</i>	
14:00-14:40	J. Stachel (Heidelberg)	<u>Challenges for heavy ion physics at the LHC</u>
14:45-15:25	G. Weiglein (Durham)	<u>Supersymmetry at the LHC</u>
15:30-16:00	<i>Coffee break</i>	
16:00-16:40	G. Polesello (INFN Pavia)	<u>SUSY at the LHC - The experimental challenge</u>
16:45-18:00	Chair: N.N.	<i>Discussion session</i>

Saturday, August 4

9:00-9:40	G. Landsberg (Brown)	<u>Experimental signatures for extra dimensions</u>
9:45-10:25	A. Pomarol (Barcelona)	<u>Extra dimensional theories</u>
10:30-11:00	<i>Coffee break</i>	
11:00-11:40	Y. Nomura (Berkeley)	The hierarchy problem
11:45-12:25	K. Desch (Bonn)	<u>The ILC and its complementarity to the LHC</u>
12:30-13:10	M. Drees (Bonn)	<u>Cosmology at the LHC</u>
13:15-14:30	<i>Lunch</i>	
15:00	<i>End of the Workshop</i>	

Last update: August 17, 2007 by M. Maniatis, comments to [maniatis](#)

IRTG Lecture Week 2007

Programme

Wednesday 11/4

14:00-14:15 Welcome (Auditorium B)

14:15-15:45 **Lecture** "Basic Concepts of Real Time Systems", [Dieter Röhrich](#) (Bergen)
[ppt](#)

Coffee Break

16:00-17:30 **Lecture** "Computer Architecture: Hardware and Software", [Boris Wagner](#) (Bergen) [ppt](#) [pdf](#) [odp](#)

Thursday 12/4

9:15-10:45 **Lecture** "Data Acquisition at FAIR", [Walter Müller](#) (GSI) [ppt](#)

Coffee Break

11:15-12:45 **Lecture** "Interprocess communication", [Dieter Röhrich](#) and [Sebastian Bablok](#) (Bergen) [sockets.ppt](#) [threads.ppt](#)

13:00-14:30 Lunch at Høyskolen

14:30-15:45 **Hands-on Exercise I**

Coffee Break

16:00-18:00 **Hands-on Exercise I**

Friday 13/4

9:15-10:45 **Lecture** "Data Acquisition in Industry", [Bernhard Skaali](#) (Oslo) [pdf](#) [ppt](#) [movie](#)

Coffee Break

11:15-12:45 **Lecture** "Device Drivers", [Dag Toppe Larsen](#) (Bergen)

13:00-14:30 Lunch at Høyskolen

14:30-15:45 **Hands-on Exercise II**

Coffee Break

16:00-18:00 **Hands-on Exercise II**

19:00-21:00 **Friday the 13th Reception**

Saturday 14/4

9:15-10:45 **Lecture** "Data Acquisition on satellites", [Olav Torheim](#) and [Yngve Skogseide](#) (Bergen)

Coffee Break

11:15-12:45 **Lecture** "Detector interface and hardware interrupts (based on the ALICE DCS board)", [Johan Alme](#) and [Sebastian Bablok](#) (Bergen)

13:00-14:30 Lunch at IFT

14:30-15:45 **Hands-on Exercise III**

Coffee Break

16:00-18:00 **Hands-on Exercise III**

Sunday 15/4

9:15-13:00 **Project Presentations**

All lectures will be in Auditorium B. The hands-on exercises will be on the 2nd floor of the Physics Department.

Web Manager of this page: [Joakim Nystrand](#).



Workshop on 3D-detectors

Monday / Tuesday 17 - 18 September 2007

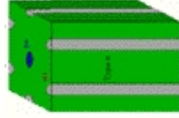

Oslo Research Park
Gautstadalleen 21
0321 Oslo
Meeting room 4

Organizer: B. Skaali, phone +47 9520 9239
t.b.skaali@fys.uio.no

Monday 10:00	Bernhard Skaali, Univ. of Oslo Steinar Stappes, Univ. of Oslo / CERN Tobias Haas, DESY Einar Nygård, Interon AS Joar M. Østby, SINTEF Bengt Svensson, Univ. of Oslo Workshop dinner	Opening address Instrumentation for High Energy Particle and Nuclear Physics Pixel Detector R&D towards an ILC Vertex Detector Technology development with CERN for detectors and electronics, experiences and challenges ASIC activities at SINTEF Visit to the Micro- and Nano-technology fMNa lab Restaurant Jeppe, Vindern
Monday 15:00	Oswin Ehrmann, Fraunhofer Institut IZM, Berlin	Water Level System Integration
Monday 18:00	Are Strandlie, Gjøvik Univ. College and UiO	Track reconstruction - from bubble chambers to the LHC
Tuesday 10:00	Erlend Bolle, Univ. of Oslo Thor-Erik Hansen, SINTEF All	Atlas Pixel Replacement / Upgrade and Measurements on 3D sensors 3-D Radiation Detector Project at SINTEF Discussion

An interesting detector technology which was not presented at the workshop is SOI. It is referred to the paper by T. Tsuboyama (KEK) at the 11th Vienna Conference on Instrumentation, Feb. 2007, http://rd.kek.jp/slides/vci2007/soi_tsuboyama.pdf

1 Registration

All participants are requested to come to the conference office on Monday morning between 8:30 and 9:30 a.m. Here you can obtain further information about the event and pay the registration fee, if you haven't already done so. There will also be a short welcome address by the organisers on Monday during the lunch break, where you can ask further questions.

Conference office: Room 161, 1st floor, Albert-Ueberle-Str. 3-5, Mrs. Krämer (+49 6221 54 9212)

2 Programme

2.1 Morning lectures (9:30-12:30)

Tracking in High Energy Physics

Carsten Niebuhr (DESY, Hamburg)
& Guillaume Leibenguth (IPP, ETH Zuerich)
Phil 12 SR

Lattice QCD

Kurt Langfeld (Plymouth, UK)
Phil 19 SR

Dark Matter in the Universe

Kris Sigurdson (U. of British Columbia)
Phil 12 gHS

Physics with Antimatter – Science, not fiction

Carsten Welsch (U. Heidelberg)
& Dieter Grzonka (FZ - Jülich)
Phil 12 kHS

Philosophy, Science and Environmental Realism

Giridhari Lal Pandit (U. of Delhi, India)
A-Ue 3-5 Bib

2.2 Afternoon lectures (14:00-17:00)

Quantum Information and Quantum Optics

Jian-Wei Pan (U. Heidelberg)
A-Ue 3-5 SR

International Linear Collider: Physics, Machine, Experiments

Peter Wienemann
Phil 12 kHS

String/Gauge Theory Correspondence in QCD

Kasper Peeters (Utrecht U., Netherlands)
Phil 19 SR

The non-Standard Model Higgs Boson(s)

Riccardo Barbieri (PISA, Italy)
Phil 12 SR

Global Warming

Klaus Pfeilsticker (U. Heidelberg)
Phil 12 gHS

Methods from Physics in Finance

Hans Peter Deutsch (d-fine, Frankfurt)
A-Ue 3-5 Bib

McKinsey Single Lecture (Monday 17:30-18:30) Perspectives für avoiding Greenhouse Gases in Germany - Potential and Costs

Kalle Greven (McKinsey&Company, Cologne)
Phil 12 gHS

2.3 Hans Jensen Invited Lecture (Thursday, 17:30)

Endless Universe:

A Voyage Beyond the Big Bang

Paul J. Steinhardt (Princeton, USA)
Phil 12 gHS

3 Breaks and Events

3.1 Coffee breaks (around 11:00 and 15:30)

in front of Phil 12 gHS
in front of A-Ue 3-5 Bib

3.2 Lunch break (12:30-14:00)

in "Neuer Hörsaal", Albert-Ueberle-Str. 3-5

3.3 McKinsey party with beer and pretzles (Monday, 18:30- ...)

4 Legend

Phil 12 gHS: "Großer Hörsaal"
(Large lecture theatre),
1st floor,
Institute of Physics,
Philosophenweg 12

Phil 12 kHS: "Kleiner Hörsaal",
(Small lecture theatre)
2nd floor,
Institute of Physics,
Philosophenweg 12

Phil 12 SR: Seminar room,
3rd floor,
Institute of Physics,
Philosophenweg 12

A-Ue 3-5 Bib: former library,
3rd floor,
Institute of Physics,
Albert-Ueberle-Str. 3-5

A-Ue 3-5 SR: Seminar room,
1st floor,
Institute of Physics
Albert-Ueberle-Str. 3-5

Phil 19 SR: Seminar room,
Institute of Theoretical Physics
Philosophenweg 19

A-Ue 3-5
CIP-Pool: Computer room,
2nd floor,
Institute of Physics,
Albert-Ueberle-Str. 3-5,

5 Schedule

Monday

08:30-09:30 Registration in
Albert-Ueberle-Str. 3-5,
1st floor, room 161

09:30-12:30 Morning lectures

12:30-14:00 Lunch, welcome address

14:00-17:00 Afternoon lectures

17:30-18:30 McKinsey lecture

18:30- ... McKinsey party with beer
and pretzles

Tuesday

09:30-12:30 Morning lectures

12:30-14:00 Lunch

14:00-17:00 Afternoon lectures

Wednesday

09:30-12:30 Morning lectures

12:30-14:00 Lunch

14:00-17:00 Afternoon lectures

Thursday

09:30-12:30 Morning lectures

12:30-14:00 Lunch

14:00-17:00 Afternoon lectures

17:30-19:00 Hans Jensen Invited Lecture
Philosophenweg 12,
"Großer Hörsaal"

19:30- ... d-fine barbecue

Friday

09:30-12:30 Morning lectures

12:30-14:00 Lunch

14:00-17:00 Afternoon lectures

6 Map



- 1 Institute of Theoretical Physics, Seminarroom, Philosophenweg 19
- 2 Institute of Theoretical Physics, library, Philosophenweg 16
- 3 Institute of Physics, "Kleiner Hörsaal", Philosophenweg 12
- 4 Institute of Physics, "Großer Hörsaal", Philosophenweg 12
- 5 Institute of Physics, Technical workshop, Philosophenweg 12
- 6 "Neuer Hörsaal", Albert-Überle-Str. 3-5
- 7 Institute of Physics, Technical workshop, Philosophenweg 12
- 8 Institut of Theoretical Astrophysics, Albert-Überle-Str. 3-5
- 9 Albert-Überle-Str.1
- 10 Dean of the Faculty of Physics and Astronomy, Albert-Überle-Str.
- 11 Central Office, Graduate School of Fundamental Physics

7 Supported by



McKinsey&Company



Deutsche
Forschungsgemeinschaft



DFG



XIX HEIDELBERG PHYSICS GRADUATE DAYS 08.10. - 12.10.2007

at the Faculty of
Physics and Astronomy
of the University of Heidelberg

Programme





XX Heidelberg Physics Graduate Days (31.03.-04.04.2008) at the Faculty of Physics and Astronomy of the University of Heidelberg

Courses are conceived for advanced students in physics, in particular for doctoral, masters or diploma students. The goal of the lecture series is to expand the general knowledge of students and to deepen their understanding of special topics and methods. Each course runs every day for five days either in a morning or afternoon slot.

Morning Courses (Monday to Friday, 9:30-12:30):

Bose-Einstein condensation and quantum transport of ultracold atoms	Peter Schlagheck , University of Regensburg
Practical statistics for high energy physicists	Louis Lyons , Physics Department, Oxford University
Nuclear spin dynamics in solids: computational challenges and microscopic chaos	Boris Fine , Institute of Theoretical Physics, Heidelberg
QCD at finite temperature and density, a matrix model approach	Kim Splittorff , Niels Bohr Institute, Copenhagen
High energy astrophysics	Christopher van Eldik , Max Planck Institute for Nuclear Physics, Heidelberg

Afternoon Courses (Monday to Friday, 14:00-17:00):

The physics of galaxies: observation versus theory – from the early universe to the present state	Uta Fritze , University of Hertfordshire
Open quantum systems and decoherence	Klaus Hornberger , Ludwig Maximilian University, Munich
New physics at the Large Hadron Collider	Jochen Dingfelder, Stephanie Hansmann-Menzemer and Victor Lendermann , Institute of Physics and Kirchhoff Institute of Physics, Heidelberg
Introduction to nano and molecular electronics	Andreas Komnik , Institute of Theoretical Physics, Heidelberg
LaTeX for physicists	Joachim Lammarsch , University Computing Center, Heidelberg
Unified Modelling Language for object oriented design – a blessing or a curse?	André Schüngel , SNP AG, Heidelberg (Single Lecture, Monday, 17:30-18:30)

Hans Jensen Invited Lecture

(02.04.2008, 17:30, Great Lecture Theatre, Philosophenweg 12):

From spinwaves to giant magnetoresistance (GMR) sensors: the story of an invention

Professor Peter Grünberg
Nobel Laureate in Physics, 2007
Forschungszentrum Jülich



Registration and further information on the internet under: <http://gsfp.physi.uni-heidelberg.de/graddays/>



Appendix B

List of Contacts to Abroad

Reisen 2005					
Name	Schulung	Konferenz	Seminare	Aufenthalte	Zeit
Schenk			Kollaborations- meeting, Slac USA		14.02.- 28.02.05
Knopf Jan				Beamtest DESY, Hamburg	17.02.-01.03.05
Knopf Jan		DPG Tagung, Berlin			03.03. -09.03.05
Knopf Jan		Outer-Tracking, Warschau			09. - 11.02.05
Knopf Jan			Meeting, Hamburg		9.03.- 10.03.05
Hafermann		DPG Tagung, Berlin			03.03. - 09.03.05
Emschermann David			Kollaborations- meeting, CERN		28.02. -03.03.05
Böhm Barbara		DPG Tagung, Berlin			03.03. -09.03.05
Knopf Jan				Medien Scale Test, NIKHEF Amsterdam	11.04. - 15.04.05
Rühr Frederik		DPG Tagung, Berlin			03.03. - 09.03.05
Reisen 2005					
Name	Schulung	Konferenz	Seminare	Aufenthalte	Zeit

Rühr Frederik			Level1 Calorimeter Trigger Joint Meeting		06.04.05 -08.04.05
Emschermann David		DPG Tagung, Berlin			03.03. - 12.03.05
Alt Torsten		2 nd Workshop, Bergen			31.03-09.04.05
Jung Andreas		DPG Tagung, Berlin			03.03. -09.03.05
Tröger Gerd		2 nd Workshop, Bergen			31.03-09.04.05
De Cuveland Jan		2 nd Workshop, Bergen			03.04- 07.04. 05
Knopf Jan		LHCB Woche, CERN			06.06.- 08.06.05
Cordier Eberhard			Kollaborations Meeting, FOPI, Split		25.05.- 30.05.05
Victor Andrei			L1-Calormiter Trigger Joint Meeting, Mainz		06.04.- 08.04.05
Emschermann David		2 nd Workshop, Bergen			30.03. -0804.05
Emschermann David		TRD Workshop, Ostor Italien			06.09.- 12.09.05

Reisen 2005					
Name	Schulung	Konferenz	Seminare	Aufenthalte	Zeit
Cordier Eberhard		CBM Workshop, Piaski Polen			05. - 11.09 05
Rühr Frederik				CERN	19.-29.09.05

Reisen 2006					
Name	Schulung	Konferenz	Seminare	Aufenthalte	Zeit
Merschmeyer Markus				CERN	15.02. -05.03.06
Soualah Rachik		Lecturweek, Oslo			05.03. - 11.03.06
Alt Torsten		Lecturweek, Oslo			05.03. - 11.03.06
Tröger Gerd		Lecturweek, Oslo			05.03. - 11.03.06
Jung		Lecturweek, Oslo			05.03. - 11.03.06
Merschmeyer Markus		Lecturweek, Oslo			05.03. - 11.03.06
Knopf Jan		PVSS Workshop, CERN			29.01. - 03.02.06
Andrei Victor		Lecturweek, Oslo			05.03. - 11.03.06
Knopf Jan				CERN	05.03.-09.03.06
Knopf Jan		DPG-Tagung, Dortmund			27.03. - 31.03.06
Rühr Frederik			ATLAS Calorimeter Trigger Joint Meeting		17.01. - 19.01.06
Reisen 2006					
Name	Schulung	Konferenz	Seminare	Aufenthalte	Zeit

Merschmeyer Markus		DPG Tagung, Münster			19.03.- 26.03.06
Soualah Rachik				CERN	11.03.-16.03.06
Soualah Rachik		DPG Tagung, München			19.03.-25.03.06
Rühr Frederik		Oslo			05.03.06 - 10.03.06
Rühr Frederik		DPG Tagung, Dortmund			28.03. - 30.03.06
Rühr Frederik				CERN	03.04. - 06.04.06
Rühr Frederik				CERN	11.04. - 13.04.06
Rühr Frederik				CERN	25.04. - 28.04.06
Rühr Frederik				CERN	09.05.. - 11.05.06
Merschmeyer Markus			ISHIP Symposium Frankfurt		03.04. - 05.04.06
Böhm Barbara				Strahlzeit - München	12.06. - 15.06.06
Emschermann David		LHC. Cern			20.03. - 22.03.06
Reisen 2006					
Name	Schulung	Konferenz	Seminare	Aufenthalte	Zeit
Emschermann David		ALICE-Woche, Bologna It.			19.06. - 23.06.06
Knopf Jan		LHCb-Woche Amsterdam			06.06. - 08.06.06

Tröger Gerd		10. Int. Konferenz on Optimis. Of Electrial Equipments, Brasov, Rum.			17.05.- 21.05.06
Andrei Victor		L1 Calo Software Workshop, CERN			21.05. - 24.05.06
Andrei Victor		L1 Calo Database Workshop, CERN			29.01. - 01.02.06
Soualah Rachik		Workshop Madrid			01.04. - 09.04.06
Böhm Barbara				TU München	10.07. - 11.07.06
Knopf Jan			Nutzertreffen		05.07.- -06.07.06
Knopf Jan		LHCB Woche, CERN			29.05. - 01.06.06
Emschermann David				CERN	03.07. - 05.07.06
Emschermann David			TRD-Status Meeting, Münster		22.01. - 24.01.06

Reisen 2006					
Name	Schulung	Konferenz	Seminare	Aufenthalte	Zeit
Andrei Victor			ATLAS Calo Trigger Meeting, Abingdon UK		27.06. - 01.07.06
Rühr Frederik				CERN	02.05. - 05.05.06

Rühr Frederik		ATLAS Overview Week, Stockholm			09.07. - 18.07.06
Rühr Frederik			AtlasLevel 1 Calo Meeting		28.06.- 30.06.06
Emschermann David		Athen			08.08. - 09.08.06
Emschermann David				CERN	15.08. - 18.08.06
Emschermann David				CERN	11.03. - 17.03.06
Soualah Rachik		LHC Expekting Triest			10.09. - 17.09.06
Merschmeyer Markus			Kollaborationstreffen, Warschau		13.09. - 16.09.06
Jung Andreas		2006 Europaen School of High Energie Physik, Stockholm			17.06. - 01.07.06
Emschermann David		Lecturweek der IRTG, Oslo			05.03. - 11.03.06

Reisen 2006

Name	Schulung	Konferenz	Seminare	Aufenthalte	Zeit
De Cuveland Jan		Lecturweek der IRTG, Oslo			05.03. - 13.03.06
Andrei Victor			L1Calo Monitoring Meeting		18.07. - 22.07.06
Knopf Jan		Konferenz Valencia			25.09. - 30.09.06
Knopf Jan				CERN	09.10. - 14.10.06

Knopf Jan				Dortmund	20.09. - 22.09.06
Emschermann David				CERN	28.09. - 14.10.06
Cordier Eberhard			FOPI Collaborations Meeting, Warschau		13.09. - 16.09.06
Knopf Jan				CERN	05.03. - 09.03.06
Cordier Eberhard		DPG Frühjahr, München			20.03. - 24.03.06
Knopf Jan				CERN	06.11. - 10.11.06
Andrei Victor				CERN	22.10. - 27.10.06
Andrei Victor				CERN	07.11. - 10.11.06
Reisen 2006					
Name	Schulung	Konferenz	Seminare	Aufenthalte	Zeit
Jung Andreas			IRTG Vorlesungswoche, Heidelberg		03.10. - 08.10.06
Knopf Jan				CERN	27.11. - 01.12.06
Knopf Jan				CERN	18.12. - 22.12.06
Rühr Frederik				CERN	04.12. - 07.12.06
Rühr Frederik				CERN	11.12. - 14.12.06

Knopf Jan				CERN	23.10. - 27.10.06
Emschermann David				DERN	27.11. - 01.12.06
Alt Torsten		H-RORC Clusterfinder Workshop, Sardinien			26.11. - 30.11.06

Herrmann Oslo					
Lindenstru Oslo					
Schulz-Coulon Oslo					

Reisen 2007					
Name	Schulung	Konferenz	Seminare	Aufenthalte	Zeit
Gerd Tröger				Darmstadt	01.03. - 01.03.07
Souahlah Rachik		Alice week, Münster			12.02. - 16.02.07
Knopf Jan				GENF	22.01. - 27.01.07
Knopf Jan				GENF	29.01. - 01.02.07
Knopf Jan				GENF	12.03. - 16.03.07
Soualah Rachik		DPG Tagung, Giessen			12.03. - 15.03.07
Emschermann Davic		DPG Tagung, Giessen			13.03. - 13.03.07
De Cuveland Jan		DPG Tagung, Giessen			14.03. - 14.03.07
Emschermann David		Alice Week, Münster			12.02. - 16.02.07
Emschermann David			TRD Meeting, Rolandseck		30.03. - 01.04.07
Knopf Jan				Genf	18.04. - 19.04.07
Alt Torsten		IRTG Lectur Week, Bergen			10.04. - 15.04.07
Reisen 2007					

Name	Schulung	Konferenz	Seminare	Aufenthalte	Zeit
Jung Andreas		IRTG Konferenz, Bergen			09.04. - 15.04.07
Rühr Frederic			ATLAS Level-1 Calorimeter Trigger Meeting		15.03. - 15.03.07
Knopf Jan		IRTG Konferenz, Bergen			10.04. - 15.04.07
Soualah Rachik		IRTG Konferenz, Bergen			10.04. - 15.04.07
De Cuveland Jan		IRTG Konferenz, Bergen			10.04. - 15.04.07
Adametz Aleksandra		IRTG Konferenz, Bergen			10.04. - 15.04.07
Tröger Gerd		IRTG Konferenz, Bergen			10.04. - 15.04.07
Tröger Gerd		DATE 2007 Konferenz, Nizza			15.04. - 21.04.07
De Cuveland Jan				CERN	23.04. - 30.04.07
Andrei Victor				CERN	23.04. - 25.04.07
Emschermann David				CERN	05.03. - 09.03.07
Emschermann David				CERN	01.05. - 10.05.07
Reisen 2007					
Name	Schulung	Konferenz	Seminare	Aufenthalte	Zeit

Emschermann David				CERN	24.04. - 28.04.07
Emschermann David				CERN	19.03. - 28.03.07
Jung Andreas		Realtime 07 Konferenz, USA			28.04. - 05.05.07
Rühr Frederik		IRTG Konferenz, Bergen			11.04. - 15.04.07
Knopf Jan				CERN	04.06. - 07.06.07
Emschermann David		IRTG Konferenz, Bergen			11.04. - 15.04.07
Emschermann David				CERN	05.02. - 08.02.07
Thäder Jochen		ALICE Week, Münster			13.02. - 15.02.07
De Cuveland jan				Münster	23.05. - 24.05.07
Emschermann David				CERN	26.06. - 29.06.07
Emschermann David				CERN	17.07. - 20.07.07
Emschermann David				CERN	02.07. - 06.07.07
Rühr Frederik			ALICE Trigger Week, CERN		04,06, - 05.06.07
Reisen 2007					
Name	Schulung	Konferenz	Seminare	Aufenthalte	Zeit

Rühr Frederik		ATLAS Hadronic Calibr. Workshop, Mailand			25.04. - 28.04.07
Emschermann David				CERN	22.07. - 27.07.07
Andrei Victor			ATLAS Lebel-1 Cal. Trigger Joint Meeting, Stockholm		26.06. - 29.06.07
Emschermann David				CERN	02.08. - 04.08.07
Andrei Victor			ATLAS Lebel-1 Cal. Trigger Joint Meeting, Mainz		14.03. - 15.03.07
Tröger Gerd		IRTG Lecturweek			16.09. - 20.09.07
De Cuveland Jan				CERN	23.07. - 04.08.07
Andrei Victor			L1Cal Monitoring Meeting	CERN	16.07. - 18.07.07
Andrei Victor				CERN	23.07. - 27.07.07
Andrei Victor				CERN	23.08. - 29.08.07
Andrei Victor		Topical Workshop, Prag			03.09. - 05.09.07
Reisen 2007					
Name	Schulung	Konferenz	Seminare	Aufenthalte	Zeit
Emschermann David		Lecturweek der IRTG, Oslo			16.09. - 20.09.07

Rühr Frederic		Europaen School of High Energy Physics, Trest			19.08. - 01.09.07
De Cuveland Jan				CERN	27.08. - 31.08.07
Rettig Felix				CERN	10.08. - 12.08.07
Rettig Felix				CERN	23.07. - 31.07.07
Andrei Victor			ATLAS L1 Cal Meeting, CERN		16.10. - 19.10.07
Rettig Felix		IRTG Lecturweek, Oslo			16.09. - 20.09.07
Emschermann David				CERN	29.10. - 02.11.07
Emschermann David				CERN	30.09. - 05.10.07
Rühr Frederic			ATLAS Trigger Week		05.11. - 08.11.07
Rühr Frederic			ATLAS L1 Cal Meeting, CERN		16.10. - 19.10.07
Rühr Frederic			ATLAS Meetin, Berlin		19.09. - 21.09.07

Reisen 2007

Name	Schulung	Konferenz	Seminare	Aufenthalte	Zeit
Rühr Frederik		IRTG Lecturweek, Oslo			16.09. - 19.09.07
Rettig Felix				CERN	07.12. - 18.12.07

Rettig Felix				CERN	29.10. - 06.11.07
Reischl Andreas		IRTG Lecturweek, Oslo			16.09. - 19.09.07



Bibliography

Group J. Stachel

- [1] D. Adamova et al., CERES Collaboration, Beam Energy and Centrality Dependence of Two-Pion Bose-Einstein Correlations at SPS Energies, Nucl. Phys. **A714** (2003) 124.
- [2] S. Damjanovic for the CERES Collaboration, Low-mass dilepton pair production in Pb-Au Collisions at 40 A GeV, Pramana J. of Phys. **60** (2003) 1067.
- [3] D. Adamova et al., CERES Collaboration, Universal Pion Freeze-out in Heavy Ion Collisions, Phys. Rev. Lett. **90** (2003) 022301.
- [4] D. Adamova et al., CERES Collaboration, Enhanced production of low mass electron pairs in 40 A GeV Pb-Au, Phys. Rev. Lett. **91** (2003) 042301, nucl-ex/0209024
- [5] A. Andronic et al., the ALICE TRD Collaboration, Pulse height measurements and electron attachment in drift chambers operated with Xe,CO₂ mixtures, Nucl. Instr. Meth. Phys. Res. **A498** (2003) 143.
- [6] A. Andronic, P. Braun-Munzinger, K. Redlich, J. Stachel, Statistical hadronization of charm at SPS, RHIC and LHC, Proc. Quark Matter 2002, Nucl. Phys. **A715** (2003) 529c, nucl-th/0209035.
- [7] H. Tilsner, H. Appelshäuser for the CERES Collaboration, Two-Pion Bose-Einstein Correlations at SPS Energies, Proc. Quark Matter 2002, Nucl. Phys. **A715** (2003) 607c.
- [8] J. Slivova for the CERES Collaboration, Flow and non-flow event anisotropies at the SPS, Proc. Quark Matter 2002, Nucl. Phys. **A715** (2003) 615c, nucl-ex/0212013.
- [9] J.P. Wessels for the CERES Collaboration, Latest Results from CERES/NA45, Proc. Quark Matter 2002, Nucl. Phys. **A715** (2003) 262c.

BIBLIOGRAPHY

- [10] L. Musa for the ALICE Collaboration, The Time Projection Chamber for the ALICE Experiment, Proc. Quark Matter 2002, Nucl. Phys. **A715** (2003) 843.
- [11] T. Mahmoud for the ALICE TRD Collaboration, The ALICE transition radiation detector, Nucl. Instr. Meth. Phys. Res. **A502** (2003) 127.
- [12] H. Sako for the CERES collaboration, hadron correlations and fluctuations in 40, 80, and 158 A GeV/c Pb-Au collisions, Proc. XXXVI-IIth Rencontres de Moriond, QCD and High Energy Hadronic Interactions, Les Arcs, France, March 2003, nucl-ex/0305011.
- [13] P. Braun-Munzinger, K. Redlich, J. Stachel, Particle Production in Heavy Ion Collisions, Invited review for Quark Gluon Plasma 3, eds. R. C. Hwa and Xin-Nian Wang (World Scientific Publishing) 491, nucl-th/0304013.
- [14] A. Andronic, P. Braun-Munzinger, K. Redlich, J. Stachel, Statistical hadronization of charm in heavy-ion collisions at SPS, RHIC and LHC, sub. Phys. Lett. **B571** (2003) 36, nucl-th/0303036.
- [15] J.P. Wessels for the ALICE TRD Collaboration, The ALICE Transition Radiation Detector, Proc. 8th International Conference on Advanced Technology and Particle Physics (ICATPP 2003), Como, Italy, Oct 2003. Published in *Como 2003, Astroparticle, particles and space physics, detectors and medical physics applications* p517.
- [16] D. Adamova et al., CERES collaboration, Event-by-event fluctuations of the mean transverse momentum in 40, 80, 158 A GeV/c Pb - Au collisions, Nucl. Phys. **A727** (2003) 97, nucl-ex/0305002.
- [17] J. Baechler et al., the ALICE TPC Collaboration, The ALICE Time Projection Chamber: a Technological Challenge in the LHC heavy ion physics, Nucl. Instrum. Meth. **A518** (2004) 94.
- [18] A. Andronic for the Alice collaboration, Energy loss of pions and electrons of 1 to 6 GeV/c in drift chambers operated with Xe, CO₂ (15%), Nucl. Instr. Meth. **A519** (2004) 508-517, physics/0310122.
- [19] J. Bielcikova, S. Esumi, K. Filimonov, S. Voloshin, J.P. Wurm Elliptic flow contribution to two particle correlations at different orientations to the reaction plane, Phys. Rev. **C69** (2004) 021901(R), nucl-ex/0311007.
- [20] H. Appelshäuser for the CERES Collaboration, Event-by-event fluctuations of the mean transverse momentum at SPS energies, Prog. Part. Nucl. Phys. **53** (2004) 253.

BIBLIOGRAPHY

- [21] G. Agakichiev et al., CERES collaboration, Semi-hard scattering unraveled from collective dynamics by two-pion correlations in 158 A GeV/c Pb + Au collisions, Phys. Rev. Lett. **92** (2004) 032301, nucl-ex/0303014.
- [22] J.P. Wurm and J. Bielcikova for the CERES Collaboration, Elliptic flow and semi-hard scattering at SPS, Proc. XXXIX Recontres de Moriond, QCD and High Energy Hadronic Interactions, La Thuile, Italy, 2004.
- [23] A. Andronic for the ALICE TRD collaboration, Electron identification performance with ALICE TRD prototypes, Nucl. Instr. Meth. **A522** (2004) 40, physics/0402131.
- [24] O. Busch for the ALICE TRD collaboration, Transition Radiation Spectroscopy with Prototypes of the ALICE TRD, Nucl. Instr. Meth. **A522** (2004) 45, physics/0404106.
- [25] P. Braun-Munzinger, J. Stachel, C. Wetterich, Chemical Freeze-out and the QCD Phase Transition Temperature, Phys. Lett. **B596** (2004) 61, nucl-th/0311005.
- [26] O. Busch for the ALICE TRD collaboration, Results from prototype tests for the ALICE TRD, Nucl. Instr. Meth. **A525** (2004) 153.
- [27] A. Andronic et al., ALICE TRD collaboration, Space charge in drift chambers operated with the Xe,CO₂ (15%) gas mixture, Nucl. Instr. Meth. **A525** (2004) 447-457; physics/0402043.
- [28] H. Sako and H. Appelshäuser for the CERES Collaboration Event-by-event fluctuations in 40, 80, and 158 A GeV/c Pb+Au collisions, Proc. Quark Matter 04, J. Phys. **G30** (2004) S1371, nucl-ex/0403037.
- [29] A. Marin for the CERES Collaboration, New results from CERES, Proc. Quark Matter 04, J. Phys. **G30** (2004) S709, nucl-ex/0406007.
- [30] P. Glässel for the ALICE TPC Collaboration, The ALICE TPC - an innovative device for heavy-ion collisions at the LHC Quark Matter 04, J. Phys. **G30** (2004) S1083.
- [31] C. Lippmann for the ALICE TRD collaboration, Position resolution and electron identification with prototypes of the ALICE TRD, Nucl. Instr. Meth. **A535** (2004) 457.
- [32] C. Garabatos for the ALICE collaboration, The ALICE TPC, Nucl. Instrum. Meth. **A535** (2004) 197, 2004.

BIBLIOGRAPHY

- [33] F. Carminati et al., ALICE Collaboration, ALICE: Physics Performance Report, Vol.1, J. Phys. **G30** (2004) 1515.
- [34] J. Mercado for the ALICE TRD Collaboration, The ALICE transition radiation detector readout electronics, Proc. SUSSP58, St. Andrews Scotland 2004, (Taylor & Francis, Boca Raton, 2006) 247.
- [35] H. Appelshäuser and H. Sako for the CERES Collaboration, Event-by-event fluctuations at the SPS, Proc. Int. Nucl. Phys. Conf., Göteborg, Sweden, 2004, Nucl. Phys. **A752** (2005) 394c, nucl-ex/0409022.
- [36] J. Bielcikowa for the CERES Collaboration, semihard scattering unraveled from collective dynamics at $\sqrt{s} = 17$ GeV, J. Phys. **G31** (2005) S465, nucl-ex/0412047.
- [37] A. Marin for the CERES Collaboration, New Results from CERES, J. Phys. **G31** (2005) S1175.
- [38] S. Yurevich for the CERES Collaboration, Latest results on e^+e^- pair production in CERES, Nucl. Phys. **A749** (2005) 160c.
- [39] C. Adler et al., ALICE TRD collaboration, Position reconstruction in drift chambers operated with Xe/CO₂ (15%), Nucl. Instr. Meth. **A540** (2005) 140,physics/0511233 .
- [40] G. Agakichiev et al., CERES Collaboration, e^+e^- pair production in Pb - Au collisions at 158 GeV per nucleon, Eur. Phys. J. **C41** (2005) 475.
- [41] J. Bielcikova et al., CERES Collaboration, Semihard scattering unraveled from collective flow at the SPS, Eur. Phys. J. **C43** (2005) 323.
- [42] R. Schicker for the ALICE TRD Collaboration, ALICE: Physics with electrons, Conf. on Physics at LHC, Vienna, Austria, July 2004, Czech. J. Phys. **55** (2005) B375.
- [43] C. Adler for the ALICE TRD Collaboration, Electron Identification with the ALICE TRD, Proc. Hadron Collider Physics 2005, eds. M.Campanelli, A.Clark, X.Wu, (Springer) 201.
- [44] C. Adler et al., ALICE TRD collaboration, Electron/Pion Identification with ALICE TRD Prototypes using a Neural Network Algorithm, Nucl. Instr. Meth. **A522** (2005) 364, physics/0506202.
- [45] D. Miskowiec for the CERES Collaboration, Collection of CERES results, Proc. Quarkmatter 2005, Nucl. Phys. **A774** (2006) 43c, nucl-ex/0511010.

BIBLIOGRAPHY

- [46] J. Milosevic for the CERES Collaboration, Strange and charged particle elliptic flow in Pb + Au Collisions at 158 A GeV/c, Proc. Quark-matter 2005, Nucl. Phys. **A774** (2006) 503c, nucl-ex/0510057.
- [47] M. Ploskon for the CERES collaboration, Two-particle azimuthal correlations at high transverse momentum in Pb-Au at 158 A GeV/c, Acta Phys. Hung. **A27** (2006) 255, nucl-ex/0511043.
- [48] J. Stachel, Experimental Summary, Proc. ICPAQGP conference, Kolkata, India, Feb. 2005, J. Phys. **G50** (2006) 293; nucl-ex/0508025.
- [49] P. Shukla for the ALICE TRD collaboration, Dielectron physics with ALICE Transition Radiation Detector, Proc. ICPAQGP 2005, Kolkata, India, Feb 2005, J. Phys. **G50** (2006) 393.
- [50] C. Lippmann for the ALICE TRD collaboration, The ALICE Transition Radiation Detector, Proc. Int. Symposium on Detector Development for Particle, Astroparticle and Synchrotron Radiation Experiments (SNIC 2006), Menlo Park, California, 3-6 Apr 2006, p. 0043.
- [51] J. Stachel, Has the Quark-Gluon Plasma been seen? in 'Lepton and Photon Interactions at High Energies', eds. R. Brenner, C.P. de los Heros, J. Rathsman (World Scientific, Singapore, 2006) p.171 and Int. J. Mod. Phys. **A21** (2006) 1750, nucl-ex/0510077.
- [52] A. Andronic et al. for the ALICE collaboration, Transition Radiation Spectra of Electrons from 1 to 10 GeV/c in Regular and Irregular Radiators, Nucl. Instr. Meth. Phys. Res. **A558** (2006) 516, physics/0511229.
- [53] A. Andronic, P. Braun-Munzinger, J. Stachel, Hadron production in central nucleus-nucleus collisions at chemical freeze-out, Nucl. Phys. **A 772** (2006) 167, nucl-th/0511071.
- [54] R. Bailhache and C. Lippmann for the ALICE TRD collaboration, New test beam results with prototypes of the ALICE TRD, Nucl. Instr. Methods **A563** (2006) 310.
- [55] V. Angelov for the ALICE TRD collaboration, Design and Performance of the ALICE TRD Front-End Electronics, Nucl. Instr. Methods **A563** (2006) 317.
- [56] A. Wilk for the ALICE TRD collaboration, Analysis of the Electron-Pion Separation Capability with Real Size ALICE TRD Prototypes using a Neural Network Algorithm, Nucl. Instr. Methods **A563** (2006) 314.

BIBLIOGRAPHY

- [57] D. Adamova et al., CERES collaboration, Leptonic and charged kaon decay modes of the ϕ meson measured in heavy ion collisions at the CERN SPS, Phys. Rev. Lett. **96** (2006) 152301, nucl-ex/0512007.
- [58] K. Zapp, G. Ingelman, J. Rathsman, J. Stachel, Jet Quenching from soft QCD Scattering in the Quark-Gluon Plasma, Phys. Lett. **B637** (2006) 179, hep-ph/0512300.
- [59] B. Alessandro et al., ALICE Collaboration, ALICE: Physics Performance Report, Vol.2, CERN/LHCC 2005-030, J. Phys. **G32** (2006) 1295-2040.
- [60] J. Milosevic for the CERES collaboration, Strange particle production and elliptic flow from CERES, Proc. Int. Conf. on Strangeness in Quark Matter (SQM2006), J.Phys. **G32**(2006) S97, nucl-ex/0606020.
- [61] P. Glässel for the ALICE TPC Collaboration, The ALICE TPC: An innovative device for heavy ion collisions at LHC, 10th Pisa Meeting on Advanced Detectors: Frontier Detectors for Frontier Physics, La Biodola, Elba, Italy, 21-27 May 2006, Nucl. Instrum. Meth. **A572** (2007) 64.
- [62] M. Ploskon for the CERES collaboration, Two particle azimuthal correlations at high transverse momentum in Pb-Au at 158-AGeV/c, Proc. 2nd International Conference on Hard and Electromagnetic Probes of High-Energy Nuclear Collisions (Hard Probes 2006), Asilomar, California, 9-16 Jun 2006. Nucl.Phys. **A783** (2007) 527, nucl-ex/0701023.
- [63] K. Oyama for the ALICE Collaboration, Physics with ALICE transition radiation detector, Prepared for Physics at LHC, Cracow, Poland, 3-8 Jul 2006, Acta Phys. Polon. **B38** (2007) 1017.
- [64] A. Andronic, P. Braun-Munzinger, K. Redlich, J. Stachel, Statistical hadronization of heavy quarks in ultra-relativistic nucleus-nucleus collisions, Nucl. Phys. **A789** (2007) 334, nucl-th/0611023.
- [65] D. Adamova et al., CERES collaboration, Modification of the rho-meson detected by low-mass lepton-positron pairs in central Pb-Au collisions at 158 A GeV/c, sub. Phys. Lett. B, nucl-ex/0611022.
- [66] A. Andronic, P. Braun-Munzinger, K. Redlich, J. Stachel, Evidence for charmonium generation at the phase boundary in ultra-relativistic nuclear collisions, Phys. Lett. **B652** (2007) 259, nucl-th/0701079.

BIBLIOGRAPHY

- [67] D. Antonczyk and D. Miskowiec for the CERES collaboration, Pion-pion and pion-proton correlations: New results from CERES, Proc. 2nd Workshop on Particle Correlation and Femtoscopy (WPCF 2006), Sao Paulo, Brazil, 9-11 Sep 2006, Braz. J. Phys. **37** (2007) 979, hep-ph/0702219.
- [68] K. Zapp, G. Ingelman, J. Rathsman, J. Stachel, Heavy quark energy loss through soft QCD scattering in the QGP, Proc. 19th Int. Conf. on Ultra-Relativistic Nucleus-Nucleus Collisions: Quark Matter 2006 (QM2006), Shanghai, China, Nov 2006, J. Phys. **G34** (2007), hep-ph/0702201.
- [69] S. Kniese and M. Ploskon for the CERES Collaboration, Two and three-particle azimuthal correlations of high-p(t) charged hadrons in Pb - Au collisions at 158-A-GeV/c, Proc. 19th International Conference on Ultra-Relativistic Nucleus-Nucleus Collisions: Quark Matter 2006 (QM2006), Shanghai, China, Nov 2006, J. Phys. **G34** (2007) S697, nucl-ex/0703008.
- [70] L. Musa for the ALICE TPC collaboration, Commissioning of the ALICE TPC, Proc. 19th International Conference on Ultra-Relativistic Nucleus-Nucleus Collisions: Quark Matter 2006 (QM2006), Shanghai, China, Nov 2006, J. Phys. **G34** (2007) S705.
- [71] P. Christiansen for the ALICE TPC collaboration, Particle identification studies with an ALICE test TPC, Proc. 19th International Conference on Ultra-Relativistic Nucleus-Nucleus Collisions: Quark Matter 2006 (QM2006), Shanghai, China, Nov 2006, J. Phys. **G34** (2007), physics/0703097.
- [72] W. Sommer for the ALICE collaboration, Quarkonia measurements with the central detectors, Proc. 19th International Conference on Ultra-Relativistic Nucleus-Nucleus Collisions: Quark Matter 2006 (QM2006), Shanghai, China, Nov 2006, J. Phys. **G34** (2007), nucl-ex/0702045.
- [73] P. Braun-Munzinger and J. Stachel, The quest for the quark-gluon plasma, Nature **448** (2007) 302.
- [74] A. Andronic, P. Braun-Munzinger, J. Stachel, Thermal model predictions of hadron ratios at LHC, Presented at Workshop on Heavy Ion Collisions at the LHC: Last Call for Predictions, Geneva, Switzerland, 14 May - 8 Jun 2007, arXiv:0707.4076 [nucl-th].
- [75] A. Andronic, P. Braun-Munzinger, K. Redlich, J. Stachel, Statistical hadronization model predictions for charmed hadrons at LHC,

BIBLIOGRAPHY

Presented at Workshop on Heavy Ion Collisions at the LHC: Last Call for Predictions, Geneva, Switzerland, 14 May - 8 Jun 2007, arXiv:0707.4075 [nucl-th].

- [76] A. Andronic, P. Braun-Munzinger, K. Redlich, J. Stachel, Statistical hadronization of charm quarks in ultra-relativistic nucleus-nucleus collisions, Contrib. 4th Int. Workshop on Critical Point and Onset Deconfinement, Darmstadt, Germany, 9-13 Jul 2007, arXiv:0710.1851 [nucl-th].
- [77] A. Andronic, P. Braun-Munzinger, K. Redlich, J. Stachel, Charmonium and open charm production in nuclear collisions at SPS/FAIR energies and the possible influence of a hot hadronic medium, Phys. Lett. **B659** (2008) 149, arXiv:0708.1488 [nucl-th].
- [78] D. Adamova et al., The CERES/NA45 Radial Drift Time Projection Chamber, sub. Nucl. Inst. Methods, Feb. 2008, arXiv:0802.1443v1 [nucl-ex].
- [79] K. Aamodt et al., ALICE Collaboration, the ALICE Experiment at the LHC, ALICE technical paper 1, sub. JINST, January 2008.
- [80] S. Domdey, G. Ingelman, H.J. Pirner, J. Rathsman, J. Stachel, K. Zapp, QCD Evolution of Jets in the Quark-Gluon Plasma, sub. Nucl. Phys. A, March 2008, arXiv:0802.3282 [hep-ph].
- [81] D. Adamova et al., CERES collaboration, Scale-dependence of transverse momentum correlations in Pb-Au collisions at 158A GeV/c, sub. Nucl. Phys. A, March 2008, arXiv:0803.2407v1 [nucl-ex].

Group U. Uwer

- [82] B. Aubert *et al.* [BABAR Collaboration], arXiv:0710.1371 [hep-ex].
- [83] H. Deppe, U. Stange, U. Trunk and U. Uwer,
- [84] B. Aubert *et al.* [BABAR Collaboration], arXiv:0801.0697 [hep-ex].
- [85] B. Aubert *et al.* [BaBar Collaboration], Phys. Rev. D **77** (2008) 032007 [arXiv:0712.1516 [hep-ex]].
- [86] B. Aubert *et al.* [BABAR Collaboration], arXiv:0712.2249 [hep-ex].
- [87] B. Aubert *et al.* [BABAR Collaboration], arXiv:0712.3469 [hep-ex].
- [88] B. Aubert *et al.* [BABAR Collaboration], arXiv:0712.3493 [hep-ex].

BIBLIOGRAPHY

- [89] B. Aubert *et al.* [BABAR Collaboration], arXiv:0712.3503 [hep-ex].
- [90] B. Aubert *et al.* [BABAR Collaboration], arXiv:0711.0980 [hep-ex].
- [91] B. Aubert *et al.* [BaBar Collaboration], arXiv:0711.2047 [hep-ex].
- [92] B. Aubert *et al.* [BABAR Collaboration], arXiv:0711.2713 [hep-ex].
- [93] B. Aubert *et al.* [BaBar Collaboration], arXiv:0711.4417 [hep-ex].
- [94] B. Aubert *et al.* [BABAR Collaboration], arXiv:0711.4889 [hep-ex].
- [95] B. Aubert *et al.* [BaBar Collaboration], arXiv:0710.4451 [hep-ex].
- [96] B. Aubert *et al.* [BABAR Collaboration], Phys. Rev. D **77** (2008) 012002 [arXiv:0710.5763 [hep-ex]].
- [97] B. Aubert *et al.* [BaBar Collaboration], Phys. Rev. D **77** (2008) 031101 [arXiv:0710.5775 [hep-ex]].
- [98] B. Aubert *et al.* [BABAR Collaboration], Phys. Rev. Lett. **100** (2008) 021801 [arXiv:0709.1698 [hep-ex]].
- [99] B. Aubert *et al.* [BABAR Collaboration], Phys. Rev. D **76** (2007) 092006 [arXiv:0709.1988 [hep-ex]].
- [100] B. Aubert *et al.* [BaBar Collaboration], Phys. Rev. Lett. **100** (2008) 061803 [arXiv:0709.2715 [hep-ex]].
- [101] B. Aubert *et al.* [BABAR Collaboration], arXiv:0709.4165 [hep-ex].
- [102] B. Aubert *et al.* [BABAR Collaboration], Phys. Rev. Lett. **99** (2007) 261801 [arXiv:0708.0050 [hep-ex]].
- [103] B. Aubert *et al.* [The BABAR Collaboration], Phys. Rev. D **76** (2007) 111101 [arXiv:0708.0182 [hep-ex]].
- [104] B. Aubert *et al.* [BABAR Collaboration], Phys. Rev. Lett. **99** (2007) 221801 [arXiv:0708.0376 [hep-ex]].
- [105] B. Aubert *et al.* [The BABAR Collaboration], Phys. Rev. D **77** (2008) 011101 [Erratum-ibid. D **77** (2008) ERRAT,D77,019904.2008) 039903] [arXiv:0708.0963 [hep-ex]].
- [106] B. Aubert *et al.* [BABAR Collaboration], Phys. Rev. Lett. **99** (2007) 201801 [arXiv:0708.1303 [hep-ex]].
- [107] I. Abt *et al.* [HERA-B Collaboration], Eur. Phys. J. C **52** (2007) 531 [arXiv:0708.1443 [hep-ex]].

BIBLIOGRAPHY

- [108] B. Aubert *et al.* [BABAR Collaboration], arXiv:0708.1614 [hep-ex].
- [109] B. Aubert *et al.* [BABAR Collaboration], arXiv:0708.1630 [hep-ex].
- [110] B. Aubert *et al.* [BABAR Collaboration], arXiv:0708.1534 [hep-ex].
- [111] B. Aubert *et al.* [BABAR Collaboration], Phys. Rev. Lett. **99** (2007) 231802 [arXiv:0708.1544 [hep-ex]].
- [112] B. Aubert *et al.* [BaBar Collaboration], Phys. Rev. D **76** (2007) 111102 [arXiv:0708.1549 [hep-ex]].
- [113] B. Aubert *et al.* [BABAR Collaboration], Phys. Rev. D **77** (2008) 011102 [arXiv:0708.1565 [hep-ex]].
- [114] B. Aubert *et al.* [BABAR Collaboration], arXiv:0708.1652 [hep-ex].
- [115] B. Aubert *et al.* [BABAR Collaboration], arXiv:0708.1738 [hep-ex].
- [116] B. Aubert *et al.* [BABAR Collaboration], arXiv:0708.1753 [hep-ex].
- [117] B. Aubert *et al.* [BABAR Collaboration], arXiv:0708.2097 [hep-ex].
- [118] B. Aubert *et al.* [BABAR Collaboration], arXiv:0708.2248 [hep-ex].
- [119] B. Aubert *et al.* [BABAR Collaboration], Phys. Rev. D **77** (2008) 011107 [arXiv:0708.2260 [hep-ex]].
- [120] B. Aubert *et al.* [BABAR Collaboration], Phys. Rev. D **76** (2007) 092005 [arXiv:0708.2461 [hep-ex]].
- [121] B. Aubert *et al.* [BABAR Collaboration], Phys. Rev. D **76** (2007) 071104 [arXiv:0708.2543 [hep-ex]].
- [122] B. Aubert *et al.* [BABAR Collaboration], Phys. Rev. Lett. **99** (2007) 251803 [arXiv:0708.3650 [hep-ex]].
- [123] B. Aubert *et al.* [BABAR Collaboration], arXiv:0708.3702 [hep-ex].
- [124] B. Aubert *et al.* [BABAR Collaboration], arXiv:0707.1043 [hep-ex].
- [125] B. Aubert *et al.* [BABAR Collaboration], Phys. Rev. D **76** (2007) 071102 [arXiv:0707.1633 [hep-ex]].
- [126] B. Aubert *et al.* [BaBar Collaboration], Phys. Rev. D **76** (2007) 092004 [arXiv:0707.1648 [hep-ex]].
- [127] B. Aubert *et al.* [BABAR Collaboration], arXiv:0707.2655 [hep-ex].
- [128] B. Aubert *et al.* [BABAR Collaboration], arXiv:0707.2670 [hep-ex].

BIBLIOGRAPHY

- [129] B. Aubert *et al.* [BABAR Collaboration], arXiv:0707.2758 [hep-ex].
- [130] B. Aubert *et al.* [BABAR Collaboration], Phys. Rev. D **76** (2007) 091102 [arXiv:0707.2798 [hep-ex]].
- [131] B. Aubert *et al.* [BABAR Collaboration], arXiv:0707.2843 [hep-ex].
- [132] B. Aubert *et al.* [BABAR Collaboration], Phys. Rev. D **76** (2007) 051104 [arXiv:0707.2922 [hep-ex]].
- [133] B. Aubert *et al.* [BABAR Collaboration], Phys. Rev. D **77** (2008) 012003 [arXiv:0707.2980 [hep-ex]].
- [134] B. Aubert *et al.* [BABAR Collaboration], Phys. Rev. Lett. **100** (2008) 011801 [arXiv:0707.2981 [hep-ex]].
- [135] B. Aubert *et al.* [The BABAR Collaboration], Phys. Rev. Lett. **99** (2007) 241803 [arXiv:0707.4561 [hep-ex]].
- [136] I. Abt *et al.* [HERA-B Collaboration], Nucl. Instrum. Meth. A **582** (2007) 401 [arXiv:0706.0131 [physics.data-an]].
- [137] B. Aubert *et al.* [The BaBar Collaboration], Phys. Rev. D **76** (2007) 071103 [arXiv:0706.1059 [hep-ex]].
- [138] B. Aubert *et al.* [BABAR Collaboration], Phys. Rev. D **77** (2008) 011104 [arXiv:0706.2870 [hep-ex]].
- [139] B. Aubert *et al.* [BABAR Collaboration], Phys. Rev. Lett. **99** (2007) 161802 [arXiv:0706.3885 [hep-ex]].
- [140] B. Aubert *et al.* [BABAR Collaboration], Phys. Rev. D **76** (2007) 031103 [arXiv:0706.3893 [hep-ex]].
- [141] B. Aubert *et al.* [BABAR Collaboration], Phys. Rev. Lett. **98** (2007) 212001 [arXiv:hep-ex/0610057].
- [142] B. Aubert *et al.* [BABAR Collaboration], Phys. Rev. D **76** (2007) 051103 [arXiv:0705.0398 [hep-ex]].
- [143] B. Aubert *et al.* [BABAR Collaboration], Phys. Rev. D **76** (2007) 014018 [arXiv:0705.0704 [hep-ex]].
- [144] B. Aubert *et al.* [BaBar Collaboration], Phys. Rev. Lett. **99** (2007) 071801 [arXiv:0705.1190 [hep-ex]].
- [145] B. Aubert *et al.* [BABAR Collaboration], Phys. Rev. D **76** (2007) 052002 [arXiv:0705.1820 [hep-ex]].

BIBLIOGRAPHY

- [146] B. Aubert *et al.* [Babar Collaboration], Phys. Rev. D **76** (2007) 052007 [arXiv:0705.2157 [hep-ex]].
- [147] B. Aubert *et al.* [BABAR Collaboration], Phys. Rev. D **77** (2008) 032002 [arXiv:0705.4008 [hep-ex]].
- [148] B. Aubert *et al.* [BABAR Collaboration], Phys. Rev. D **76** (2007) 012008 [arXiv:0704.0630 [hep-ex]].
- [149] B. Aubert *et al.* [BABAR Collaboration], Phys. Rev. D **76** (2007) 031102 [arXiv:0704.0522 [hep-ex]].
- [150] B. Aubert *et al.* [BABAR Collaboration], arXiv:0704.0020 [hep-ex].
- [151] B. Aubert *et al.* [BABAR Collaboration], Phys. Rev. D **76** (2007) 031101 [arXiv:0704.1266 [hep-ex]].
- [152] B. Aubert *et al.* [BABAR Collaboration], arXiv:0704.1478 [hep-ex].
- [153] B. Aubert *et al.* [BABAR Collaboration], Phys. Rev. Lett. **100** (2008) 051802 [arXiv:0704.2080 [hep-ex]].
- [154] B. Aubert *et al.* [BABAR Collaboration], Phys. Rev. D **76** (2007) 011102 [arXiv:0704.3593 [hep-ex]].
- [155] B. Aubert *et al.* [BABAR Collaboration], Phys. Rev. D **76** (2007) 012004 [arXiv:hep-ex/0703008].
- [156] B. Aubert *et al.* [BABAR Collaboration], Phys. Rev. Lett. **99** (2007) 021603 [arXiv:hep-ex/0703016].
- [157] B. Aubert *et al.* [BABAR Collaboration], Phys. Rev. Lett. **99** (2007) 051801 [arXiv:hep-ex/0703018].
- [158] B. Aubert *et al.* [BABAR Collaboration], Phys. Rev. Lett. **99** (2007) 081801 [arXiv:hep-ex/0703019].
- [159] B. Aubert *et al.* [BABAR Collaboration], Phys. Rev. Lett. **98** (2007) 211802 [arXiv:hep-ex/0703020].
- [160] B. Aubert *et al.* [BABAR Collaboration], Phys. Rev. Lett. **99** (2007) 171803 [arXiv:hep-ex/0703021].
- [161] B. Aubert *et al.* [BABAR Collaboration], Phys. Rev. D **76** (2007) 051101 [arXiv:hep-ex/0703027].
- [162] B. Aubert *et al.* [BABAR Collaboration], Phys. Rev. Lett. **99** (2007) 062001 [arXiv:hep-ex/0703030].

BIBLIOGRAPHY

- [163] B. Aubert *et al.* [BaBar Collaboration], Phys. Rev. Lett. **99** (2007) 251801 [arXiv:hep-ex/0703037].
- [164] B. Aubert *et al.* [BABAR Collaboration], Phys. Rev. D **75** (2007) 111102 [arXiv:hep-ex/0703038].
- [165] B. Aubert *et al.* [BABAR Collaboration], Phys. Rev. D **76** (2007) 071101 [arXiv:hep-ex/0702010].
- [166] B. Aubert *et al.* [BaBar Collaboration], Phys. Rev. D **76** (2007) 011103 [arXiv:hep-ex/0702043].
- [167] B. Aubert *et al.* [BABAR Collaboration], Phys. Rev. D **76** (2007) 091101 [arXiv:hep-ex/0702046].
- [168] H. Albrecht *et al.* [HERA-B Outer Tracker Group], Nucl. Instrum. Meth. A **576** (2007) 312 [arXiv:physics/0701122].
- [169] B. Aubert *et al.* [BABAR Collaboration], Phys. Rev. D **75** (2007) 091103 [arXiv:hep-ex/0701035].
- [170] B. Aubert *et al.* [BABAR Collaboration], Phys. Rev. Lett. **98** (2007) 151802 [arXiv:hep-ex/0612017].
- [171] B. Aubert *et al.* [BABAR Collaboration], Phys. Rev. Lett. **98** (2007) 091801 [arXiv:hep-ex/0612020].
- [172] B. Aubert *et al.* [BABAR Collaboration], Phys. Rev. Lett. **98** (2007) 111801 [arXiv:hep-ex/0612021].
- [173] I. Abt *et al.* [HERA-B Collaboration], Phys. Lett. B **650** (2007) 103 [arXiv:hep-ex/0612024].
- [174] B. Aubert *et al.* [BABAR Collaboration], Phys. Rev. Lett. **98** (2007) 181803 [arXiv:hep-ex/0612050].
- [175] B. Aubert *et al.* [BABAR Collaboration], Phys. Rev. D **74** (2006) 111103 [arXiv:hep-ex/0611028].
- [176] B. Aubert *et al.* [BABAR Collaboration], Phys. Rev. Lett. **98** (2007) 171801 [arXiv:hep-ex/0611030].
- [177] B. Aubert *et al.* [BABAR Collaboration], Phys. Rev. D **75** (2007) 051102 [arXiv:hep-ex/0611037].
- [178] B. Aubert *et al.* [BABAR Collaboration], Phys. Rev. D **74** (2006) 091103 [arXiv:hep-ex/0610018].
- [179] B. Aubert *et al.* [BABAR Collaboration], Phys. Rev. D **75** (2007) 031101 [arXiv:hep-ex/0610027].

BIBLIOGRAPHY

- [180] B. Aubert *et al.* [BABAR Collaboration], Phys. Rev. Lett. **98** (2007) 061803 [arXiv:hep-ex/0610067].
- [181] B. Aubert *et al.* [BABAR Collaboration], Phys. Rev. Lett. **98** (2007) 051801 [arXiv:hep-ex/0610073].
- [182] B. Aubert *et al.* [BABAR Collaboration], Phys. Rev. D **75** (2007) 012003 [arXiv:hep-ex/0609004].
- [183] B. Aubert *et al.* [BABAR Collaboration], Phys. Rev. Lett. **97** (2006) 261803 [arXiv:hep-ex/0609027].
- [184] B. Aubert *et al.* [BABAR Collaboration], Phys. Rev. D **74** (2006) 111102 [arXiv:hep-ex/0609033].
- [185] B. Aubert *et al.* [BABAR Collaboration], Phys. Rev. Lett. **98** (2007) 031801 [arXiv:hep-ex/0609052].
- [186] D. Wiedner *et al.*, *Prepared for 12th Workshop on Electronics for LHC and Future Experiments (LECC 2006), Valencia, Spain, 25-29 Sep 2006*
- [187] J. Knopf, R. Muckerheide, U. Stange, U. Trunk, U. Uwer and D. Wiedner, *Prepared for 12th Workshop on Electronics for LHC and Future Experiments (LECC 2006), Valencia, Spain, 25-29 Sep 2006*
- [188] B. Aubert *et al.* [BABAR Collaboration], arXiv:hep-ex/0607103.
- [189] B. Aubert *et al.* [BABAR Collaboration], Phys. Rev. D **75** (2007) 012008 [arXiv:hep-ex/0608003].
- [190] B. Aubert *et al.* [BABAR Collaboration], arXiv:hep-ex/0608004.
- [191] B. Aubert *et al.* [BABAR Collaboration], Phys. Rev. Lett. **97** (2006) 201802 [arXiv:hep-ex/0608005].
- [192] B. Aubert *et al.* [BABAR Collaboration], Phys. Rev. Lett. **97** (2006) 221803 [arXiv:hep-ex/0608006].
- [193] B. Aubert *et al.* [BABAR Collaboration], Phys. Rev. D **74** (2006) 091102 [arXiv:hep-ex/0608009].
- [194] B. Aubert *et al.* [BABAR Collaboration], Phys. Rev. D **74** (2006) 091101 [arXiv:hep-ex/0608016].
- [195] B. Aubert *et al.* [BABAR Collaboration], arXiv:hep-ex/0608019.
- [196] B. Aubert *et al.* [BABAR Collaboration], Phys. Rev. Lett. **97** (2006) 171805 [arXiv:hep-ex/0608036].

BIBLIOGRAPHY

- [197] B. Aubert *et al.* [BABAR Collaboration], Phys. Rev. Lett. **98** (2007) 051803 [arXiv:hep-ex/0608051].
- [198] B. Aubert *et al.* [BABAR Collaboration], Phys. Rev. Lett. **97** (2006) 232001 [arXiv:hep-ex/0608055].
- [199] B. Aubert *et al.* [BABAR Collaboration], arXiv:hep-ex/0607037.
- [200] B. Aubert *et al.* [BABAR Collaboration], Phys. Rev. D **74** (2006) 051101 [arXiv:hep-ex/0607039].
- [201] B. Aubert *et al.* [BABAR Collaboration], arXiv:hep-ex/0607040.
- [202] B. Aubert *et al.* [BABAR Collaboration], arXiv:hep-ex/0607043.
- [203] B. Aubert *et al.* [BABAR Collaboration], Phys. Rev. D **75** (2007) 031103 [arXiv:hep-ex/0607044].
- [204] B. Aubert *et al.* [BABAR Collaboration], arXiv:hep-ex/0607045.
- [205] I. Abt *et al.* [HERA-B Collaboration], Eur. Phys. J. C **49** (2007) 545 [arXiv:hep-ex/0607046].
- [206] B. Aubert *et al.* [BABAR Collaboration], arXiv:hep-ex/0607048.
- [207] B. Aubert *et al.* [BABAR Collaboration], Phys. Rev. D **74** (2006) 071101 [arXiv:hep-ex/0607050].
- [208] B. Aubert *et al.* [BABAR Collaboration], arXiv:hep-ex/0607051.
- [209] B. Aubert *et al.* [BABAR Collaboration], arXiv:hep-ex/0607053.
- [210] B. Aubert *et al.* [BABAR Collaboration], arXiv:hep-ex/0607055.
- [211] B. Aubert *et al.* [BABAR Collaboration], Phys. Rev. Lett. **97** (2006) 201801 [arXiv:hep-ex/0607057].
- [212] B. Aubert *et al.* [BaBar Collaboration], arXiv:hep-ex/0607058.
- [213] B. Aubert *et al.* [BABAR Collaboration], arXiv:hep-ex/0607060.
- [214] B. Aubert *et al.* [BABAR Collaboration], arXiv:hep-ex/0607062.
- [215] B. Aubert *et al.* [BaBar Collaboration], Phys. Rev. D **74** (2006) 051106 [arXiv:hep-ex/0607063].
- [216] B. Aubert *et al.* [BABAR Collaboration], arXiv:hep-ex/0607064.
- [217] B. Aubert *et al.* [BABAR Collaboration], arXiv:hep-ex/0607065.
- [218] B. Aubert *et al.* [BABAR Collaboration], arXiv:hep-ex/0607066.

BIBLIOGRAPHY

- [219] B. Aubert *et al.* [BABAR Collaboration], arXiv:hep-ex/0607067.
- [220] B. Aubert *et al.* [BaBar Collaboration], Phys. Rev. Lett. **97** (2006) 171803 [arXiv:hep-ex/0607071].
- [221] B. Aubert *et al.* [BABAR Collaboration], arXiv:hep-ex/0607076.
- [222] B. Aubert *et al.* [BABAR Collaboration], Phys. Rev. D **76** (2007) 052005 [arXiv:hep-ex/0607077].
- [223] B. Aubert *et al.* [BABAR Collaboration], arXiv:hep-ex/0607081.
- [224] B. Aubert *et al.* [BABAR Collaboration], Phys. Rev. D **76** (2007) 111105 [arXiv:hep-ex/0607083].
- [225] B. Aubert *et al.* [BABAR Collaboration], arXiv:hep-ex/0607084.
- [226] B. Aubert *et al.* [BABAR Collaboration], arXiv:hep-ex/0607085.
- [227] B. Aubert *et al.* [BABAR Collaboration], arXiv:hep-ex/0607086.
- [228] B. Aubert *et al.* [BABAR Collaboration], Phys. Rev. Lett. **97** (2006) 211801 [arXiv:hep-ex/0607089].
- [229] B. Aubert *et al.* [BABAR Collaboration], arXiv:hep-ex/0607090.
- [230] B. Aubert *et al.* [BABAR Collaboration], arXiv:hep-ex/0607091.
- [231] B. Aubert *et al.* [BABAR Collaboration], Phys. Rev. Lett. **97** (2006) 261801 [arXiv:hep-ex/0607092].
- [232] B. Aubert *et al.* [BABAR Collaboration], Phys. Rev. Lett. **98** (2007) 141801 [arXiv:hep-ex/0607094].
- [233] B. Aubert *et al.* [BABAR Collaboration], arXiv:hep-ex/0607096.
- [234] B. Aubert *et al.* [BABAR Collaboration], arXiv:hep-ex/0607097.
- [235] B. Aubert *et al.* [BABAR Collaboration], arXiv:hep-ex/0607098.
- [236] B. Aubert *et al.* [BABAR Collaboration], arXiv:hep-ex/0607099.
- [237] B. Aubert *et al.* [BABAR Collaboration], arXiv:hep-ex/0607100.
- [238] B. Aubert *et al.* [BABAR Collaboration], arXiv:hep-ex/0607101.
- [239] B. Aubert *et al.* [BABAR Collaboration], arXiv:hep-ex/0607104.
- [240] B. Aubert *et al.* [BABAR Collaboration], arXiv:hep-ex/0607105.
- [241] B. Aubert *et al.* [BABAR Collaboration], arXiv:hep-ex/0607106.

BIBLIOGRAPHY

- [242] B. Aubert *et al.* [BABAR Collaboration], arXiv:hep-ex/0607107.
- [243] B. Aubert *et al.* [BABAR Collaboration], arXiv:hep-ex/0607108.
- [244] B. Aubert *et al.* [BABAR Collaboration], Phys. Rev. Lett. **98** (2007) 051802 [arXiv:hep-ex/0607109].
- [245] B. Aubert *et al.* [BABAR Collaboration], arXiv:hep-ex/0607110.
- [246] B. Aubert *et al.* [BABAR Collaboration], Phys. Rev. D **74** (2006) 091105 [arXiv:hep-ex/0607111].
- [247] B. Aubert *et al.* [BABAR Collaboration], arXiv:hep-ex/0607112.
- [248] B. Aubert *et al.* [BABAR Collaboration], Phys. Rev. D **74** (2006) 051104 [arXiv:hep-ex/0607113].
- [249] B. Aubert *et al.* [BABAR Collaboration], arXiv:hep-ex/0608002.
- [250] B. Aubert *et al.* [BABAR Collaboration], Phys. Rev. D **75** (2007) 072002 [arXiv:hep-ex/0606026].
- [251] B. Aubert *et al.* [BABAR Collaboration], Phys. Rev. D **74** (2006) 032005 [arXiv:hep-ex/0606031].
- [252] B. Aubert *et al.* [BABAR Collaboration], Phys. Rev. Lett. **97** (2006) 112001 [arXiv:hep-ex/0606039].
- [253] I. Abt *et al.* [HERA-B Collaboration], Eur. Phys. J. C **50** (2007) 315 [arXiv:hep-ex/0606049].
- [254] B. Aubert *et al.* [BABAR Collaboration], Phys. Rev. D **74** (2006) 072008 [arXiv:hep-ex/0606050].
- [255] B. Aubert *et al.* [BABAR Collaboration], Phys. Rev. Lett. **97** (2006) 112002 [arXiv:hep-ex/0606054].
- [256] B. Aubert *et al.* [BABAR Collaboration], Phys. Rev. D **74** (2006) 032003 [arXiv:hep-ex/0605003].
- [257] B. Aubert *et al.* [BaBar Collaboration], Phys. Rev. D **74** (2006) 031105 [arXiv:hep-ex/0605008].
- [258] B. Aubert *et al.* [BABAR Collaboration], Phys. Rev. D **74** (2006) 051102 [arXiv:hep-ex/0605017].
- [259] B. Aubert *et al.* [BABAR Collaboration], Phys. Rev. D **74** (2006) 012002 [arXiv:hep-ex/0605018].

BIBLIOGRAPHY

- [260] B. Aubert *et al.* [BaBar Collaboration], Phys. Rev. D **74** (2006) 031104 [arXiv:hep-ex/0605024].
- [261] B. Aubert *et al.* [BABAR Collaboration], Phys. Rev. D **74** (2006) 031103 [arXiv:hep-ex/0605036].
- [262] B. Aubert *et al.* [BABAR Collaboration], Phys. Rev. D **74** (2006) 011102 [arXiv:hep-ex/0605037].
- [263] B. Aubert *et al.* [BABAR Collaboration], Phys. Rev. D **74** (2006) 011107 [arXiv:hep-ex/0605044].
- [264] B. Aubert *et al.* [BABAR Collaboration], Phys. Rev. D **74** (2006) 011103 [arXiv:hep-ex/0605075].
- [265] B. Aubert *et al.* [BABAR Collaboration], Phys. Rev. D **73** (2006) 091101 [arXiv:hep-ex/0604006].
- [266] B. Aubert *et al.* [BABAR Collaboration], Phys. Rev. D **73** (2006) 092001 [arXiv:hep-ex/0604007].
- [267] B. Aubert *et al.* [BABAR Collaboration], Phys. Rev. D **74** (2006) 012001 [arXiv:hep-ex/0604009].
- [268] B. Aubert *et al.* [BABAR Collaboration], Phys. Rev. Lett. **98** (2007) 081801 [arXiv:hep-ex/0604012].
- [269] B. Aubert *et al.* [BABAR Collaboration], Phys. Rev. D **73** (2006) 112003 [arXiv:hep-ex/0604014].
- [270] B. Aubert *et al.* [BABAR Collaboration], Phys. Rev. D **74** (2006) 031101 [arXiv:hep-ex/0604016].
- [271] B. Aubert *et al.* [BaBar Collaboration], Phys. Rev. D **73** (2006) 111104 [arXiv:hep-ex/0604017].
- [272] B. Aubert *et al.* [BABAR Collaboration], Phys. Rev. D **74** (2006) 032007 [arXiv:hep-ex/0604030].
- [273] B. Aubert *et al.* [BABAR Collaboration], Phys. Rev. Lett. **96** (2006) 232001 [arXiv:hep-ex/0604031].
- [274] B. Aubert *et al.* [BABAR Collaboration], Phys. Rev. D **73** (2006) 112004 [arXiv:hep-ex/0604037].
- [275] B. Aubert *et al.* [BaBar Collaboration], Phys. Rev. D **74** (2006) 011101 [arXiv:hep-ex/0603012].
- [276] B. Aubert *et al.* [BABAR Collaboration], Phys. Rev. D **73** (2006) 071102 [arXiv:hep-ex/0603013].

BIBLIOGRAPHY

- [277] I. Abt *et al.* [HERA-B Collaboration], Phys. Lett. B **638** (2006) 13 [arXiv:hep-ex/0603015].
- [278] B. Aubert *et al.* [BABAR Collaboration], Phys. Rev. D **74** (2006) 011106 [arXiv:hep-ex/0603040].
- [279] I. Abt *et al.* [HERA-B Collaboration], Phys. Lett. B **638** (2006) 415 [arXiv:hep-ex/0603047].
- [280] B. Aubert *et al.* [BABAR Collaboration], Phys. Rev. Lett. **97** (2006) 051802 [arXiv:hep-ex/0603050].
- [281] B. Aubert *et al.* [BABAR Collaboration], Phys. Rev. Lett. **96** (2006) 251802 [arXiv:hep-ex/0603053].

A. Adametz

- [282] B. Aubert *et al.* [BaBar Collaboration], Nucl. Instrum. Meth. A **479**, 1 (2002). 21
- [283] P.F. Harrison, H.R. Quinn, The BaBar Physics Book – Physics at an Asymmetric *B* Factory, SLAC-R-504 (19 98). 21
- [284] W.-M. Yao *et al.*, J. Phys. G **33**, 1 (2006) 21, 22
- [285] E. Gamiz *et al.*, JHEP 01 (2003) 060, hep-ph/0212230, Phys. Rev. Lett. 94 (2005) 011803, hep-ph/0408044. 22

J. Knopf

- [286] J. Knopf in Letheren, M and Claude, S [LECC 2006], “12th Workshop on Electronics for LHC and Future Experiments”, CERN (2007) 46

Group K. Meier / H.-C. Schulz-Coulon

- [287] G. Aielli *et al.*, *The ATLAS Level-1 Trigger: Status of the System and First Results from Cosmic-Ray Data*, Nuclear Instruments and Methods A, vol. 582, 2007, pp. 476-481.
- [288] R. Achenbach *et al.*, Pre-production Validation of the ATLAS Level-1 Calorimeter Trigger System, IEEE Transactions on Nuclear Science, 53(2006)859863.

BIBLIOGRAPHY

- [289] J. Garvey et al., The ATLAS Level-1 Calorimeter Trigger Architecture, *IEEE Transactions on Nuclear Science*, 51(2004)356360.
- [290] J. Garvey et al., ATLAS Level-1 Calorimeter Trigger: Subsystem tests of a Jet/Energy-sum Processor Module, *IEEE Transactions on Nuclear Science*, 51(2004)23562361.
- [291] J. Garvey et al., Use of an FPGA to Identify Electromagnetic Clusters and Isolated Hadrons in the ATLAS Level-1 Calorimeter Trigger, *Nuclear Instruments and Methods A*, vol. 512 no. 3, 2003, pp. 506-516.
- [292] R. Achenbach et al., First Measurements with the ATLAS Level-1 Calorimeter Trigger Preprocessor System, *Proceedings of the Topical Workshop on Electronics for Particle Physics*, 2007, Prague, Czech Republic
- [293] R. Achenbach et al., Commissioning of the Jet/Energy-sum and Cluster Processors for the ATLAS Level-1 Calorimeter Trigger System, *Proceedings of the Topical Workshop on Electronics for Particle Physics*, 2007, Prague, Czech Republic
- [294] R. Achenbach et al., Production test rig for the ATLAS level-1 calorimeter trigger digital processors, *ATL-DAQ-CONF-2007-016*, *ATL-COM-DAQ-2007-022*, 2007. 4pp.
- [295] R. Achenbach et al., Large scale production of the multi-chip module of the ATLAS level-1 calorimeter trigger, *ATL-DAQ-CONF-2007-015*, *ATL-COM-DAQ-2007-021*, 2007. 5pp.
- [296] J.R.A. Booth et al., Commissioning Experience with the ATLAS Level-1 Calorimeter Trigger System, *Proceedings of the IEEE NPSS 15th Real Time Conference*, 2007, Fermilab, Batavia, USA
- [297] R. Achenbach et al., High-density Backplanes. Problems and Solutions, *Proceedings of the LECC2006 Workshop*, Valencia, Spain, 2006.
- [298] J. Garvey et al., Beam Test of the ATLAS Level-1 Calorimeter Trigger System, *Proceedings of the IEEE-NSS 2004 Workshop*, Rome, Italy, 2004.
- [299] J. Garvey et al., ATLAS Level-1 Calorimeter Trigger: Subsystem Tests of a Prototype Cluster Processor, *Proceedings of the 9th Workshop on Electronics for LHC Experiments*, Amsterdam, Netherlands, 2003.

BIBLIOGRAPHY

- [300] J. Garvey et al., Test results for the Jet/Energy-sum Processor of the ATLAS Level-1 Calorimeter Trigger, Proceedings of the 9th Workshop on Electronics for LHC Experiments Amsterdam, Netherlands, 2003.
- [301] J. Garvey et al., ATLAS Level-1 Calorimeter Trigger : Subsystem Tests of a Jet/Energy Sum Processor Module, Proceedings of the IEEE Nuclear Science Symposium, Portland, Oregon, USA, 2003.
- [302] J. Garvey et al., The ATLAS Level-1 Calorimeter Trigger Architecture, Proceedings of the 13th IEEE-NPSS Real Time Conference, Montreal, Canada, 2003.
- [303] A.W. Jung et al., First Results from the Third Level of the H1 Fast Track Trigger, Proceedings of the 15th Real Time Conference, 2007, Fermilab, Batavia, USA
- [304] C. Wissing et al., Performance of the H1 Fast Track Trigger operation and commissioning results, Proceedings of the IEEE-NSS 2005 Workshop, Stockholm, 2005.
- [305] C. Wissing et al., Performance of the H1 Fast Track, Proceedings of the IEEE-NPSS 2005 Workshop, Stockholm, 2005.
- [306] N. Berger et al., Performance of the H1 Fast Track Trigger, Proceedings of the IEEE-NSS 2004 Workshop, Rom, Italy, 2004.
- [307] E. Garutti et al., Application of novel Silicon-based photo-detector to calorimetry and medical physics, Proceedings of the Nuclear Science Symposium, 2007, Hawaii, USA
- [308] N. D'Ascenzo et al., Application of MPPC to Positron Emission Tomography, Proceedings of the International Workshop on New Photon Detectors, 2007, Kobe, Japan

A. Jung

- [309] I. Abt et al., *The H1 Detector at HERA*, Nucl. Instr. and Meth., vol. A386, pp.310 & 348, 1997. 39
- [310] A. Baird et al., *A fast high resolution track trigger for the H1 experiment*, IEEE Trans. Nucl. Sci., vol. 48, pp. 1276-1285, 2001. 40, 41
- [311] A. Schöning, *A fast track trigger for the H1 collaboration*, Nucl. Instrum. Meth., vol. A518, pp. 542-543, 2004. 40, 42

BIBLIOGRAPHY

- [312] J.Butterworth, H. Jung, V. Lendermann, B. Waugh, *HZTool, JetWeb, CEDAR*, Proceedings of the HERA-LHC Workshop, 2004, CERN/DESY. 41, 42
- [313] N. Berger et al., *First Results from the First Level of the H1 Fast Track Trigger*, Proc. of the 2004 NSS Symposium, Oct. 2004, Rome, Italy. 40, 42
- [314] Ch. Wissing et al., *Performance of the H1 Fast Track Trigger Operation and Commissioning Results*, Proc. of the 14th IEEE - NPSS Real time Conference 2005, p233-236, Stockholm, Sweden. 40, 42
- [315] A.W. Jung, *Abschliessende Tests der dritten Triggerstufe des H1 Fast Track Triggers*, DPG Verhandlungen, Mrz 2005, Berlin. 40, 42
- [316] A.W. Jung, *Über das Leistungsverhalten der dritten Triggerstufe bei H1*, DPG Verhandlungen, Mrz 2006, Dortmund. 40, 42
- [317] A.W. Jung, *Exklusive Endzustände mit dem Fast Track Trigger*, DPG Verhandlungen, Mrz 2007, Heidelberg. 41, 42
- [318] A.W. Jung et al., *First Results from the Third Level of the H1 Fast Track Trigger*, Proc. of the 15th IEEE - NPSS Real time Conference 2007, Chicago (Fermilab), USA. 41, 42

G. Andrei

- [319] R. Achenbach et al., *Commissioning Experience with the ATLAS Level-1 Calorimeter Trigger System*, IEEE Transactions on Nuclear Science, 2007, to be published 31, 54

F. Rühr

- [320] R. Achenbach et al., Pre-production Validation of the ATLAS Level-1 Calorimeter Trigger System, *IEEE Transactions on Nuclear Science*, 53 (2006) 859-863 54

Group U. Keschul

- [321] Gerd Troeger (Univ. Heidelberg), Ketil Roed (Univ. Bergen):Improving on FPGA Radiation Tolerance, Proceedings of "DPG Jahrestagung 2005", 2005
- [322] Gerd Troeger: Improving on FPGA Radiation Tolerance, IRTG seminar talk, 2005

BIBLIOGRAPHY

- [323] Gerd Troeger: Basics of Dynamic Reconfiguration, IRTG seminar talk, 2005
- [324] G. Troeger, J. Alme, R. Campagnolo, U. Keschull, V. Lindenstruth, L. Musa, K. Roed, D. Roehrich: Reconfiguration in ALICE and beyond, Proceedings of LECC 2005, 2005
- [325] Gerd Troeger: Radiation Damage to Electronics, IRTG seminar talk, 2005
auth:
- [326] G. Troeger, U. Keschull, V. Lindenstruth, J. Alme, K. Roed, D. Roehrich, R. Campagnolo., L. Musa: FPGAs - Reconfiguration for Radiation Tolerance, GSI Jahresbericht 2005, 2006
- [327] A.D. Oltean Karlsson, G. Troeger: An interface solution at 53.76 Gb/s input bandwidth to a single Xilinx Virtex-II Pro FPGA - a practical challenge, Optim 2006 IEEE conference, Proceedings of "Optim 2006", 2006
- [328] G. Troeger: Configuration and Radiation Tolerance Issues for Virtex-4, CBM Collaboration Meeting at GSI, 2006
- [329] J. Alme, K. Roed, K. Ullaland, D. Roehrich, G. Troeger: Case Study of a Solution for Active Partial Reconfiguration of a Xilinx Virtex-II Pro, Proceedings of "FPGAworld 2006", 2006
- [330] Gerd Troeger: SEU Test Summary, CBM Collaboration Meeting at GSI, 2007
- [331] Gerd Troeger, Improving Radiation Tolerance of FPGAs in High-Energy Physics Applications, DATE 2007 conference, PhD forum, 2007
- [332] Gerd Troeger: Data Acquisition: From the signal to the result, how does the analog measurement get into the histogram? IRTG seminar talk, 2007

G. Tröger

- [333] LECC2005 conference paper and presentation, *FPGA Dynamic Reconfiguration in ALICE and beyond* 2005-09-16 61
- [334] GSI Jahresbericht 2005, *FPGAs - Reconfiguration for Radiation Tolerance* 2006-09-01 61

BIBLIOGRAPHY

- [335] Optim 2006 IEEE conference, paper and talk, *An interface solution at 53.76 Gb/s input bandwidth to a single Xilinx Virtex-II Pro FPGA - a practical challenge* 2006-02-14 61
- [336] FPGAworld 2006 conference, paper, *Case Study of a Solution for Active Partial Reconfiguration of a Xilinx Virtex-II Pro* 2006-11-16 61

Group V. Lindenstruth

- [337] W. Trautmann *et al.* [ALADIN Collaboration], “Thermal and Chemical Freeze-out in Spectator Fragmentation,” *Phys. Rev. C* **76** (2007) 064606 [arXiv:0708.4115 [nucl-ex]].
- [338] S. Bablok *et al.*, “Front-end-electronics communication software for multiple detectors in the ALICE experiment,” *Nucl. Instrum. Meth. A* **557** (2006) 631.
- [339] T. Alt *et al.* [ALICE Collaboration], “Benchmarks and implementation of the ALICE high level trigger,” *IEEE Trans. Nucl. Sci.* **53** (2006) 854.
- [340] M. Richter *et al.* [ALICE Collaboration], “The control system for the front-end electronics of the ALICE time IEEE Trans. Nucl. Sci. **53** (2006) 980.
- [341] G. Troger *et al.*, “FPGA dynamic reconfiguration in ALICE and beyond,” *Prepared for 11th Workshop on Electronics for LHC and Future Experiments (LECC 2005), Heidelberg, Germany, 12-16 September 2005*
- [342] K. Roed *et al.*, “Irradiation tests of the complete ALICE TPC front-end electronics chain,” *Prepared for 11th Workshop on Electronics for LHC and Future Experiments (LECC 2005), Heidelberg, Germany, 12-16 September 2005*
- [343] M. Richter *et al.*, “Communication software for the ALICE TPC front-end electronics,” *Prepared for 11th Workshop on Electronics for LHC and Future Experiments (LECC 2005), Heidelberg, Germany, 12-16 September 2005*
- [344] V. Lindenstruth *et al.*, “Real-time TPC analysis with the ALICE high-level trigger,” *Nucl. Instrum. Meth. A* **534** (2004) 47 [arXiv:physics/0403063].

BIBLIOGRAPHY

- [345] V. Lindenstruth and L. Musa [ALICE Collaboration], “Fast on-detector integrated signal processing status and perspectives,” *Nucl. Instrum. Meth. A* **522** (2004) 33.
- [346] T. Alt *et al.* [ALICE Collaboration], “The ALICE high level trigger,” *J. Phys. G* **30** (2004) S1097.
- [347] H. Tilsner *et al.* [ALICE Collaboration], “The high-level trigger of ALICE,” *Eur. Phys. J. C* **33** (2004) S1041.
- [348] V. Lindenstruth and I. Kisel, “Overview of trigger systems,” *Nucl. Instrum. Meth. A* **535** (2004) 48.
- [349] V. Lindenstruth *et al.*, “Online pattern recognition for the ALICE High Level Trigger,” *IEEE Trans. Nucl. Sci.* **51** (2004) 3 [*IEEE Trans. Nucl. Sci.* **51** (2004) 383] [arXiv:physics/0310052].
- [350] G. Grastveit *et al.* [ALICE Collaboration], “FPGA co-processor for the ALICE high level trigger,” *In the Proceedings of 2003 Conference for Computing in High-Energy and Nuclear Physics (CHEP 03), La Jolla, California, 24-28 Mar 2003, pp THHT001* [arXiv:physics/0306017].
- [351] T. M. Steinbeck, V. Lindenstruth and H. Tilsner [ALICE Collaboration], “A Software Data Transport Framework for Trigger Applications on Clusters,” *In the Proceedings of 2003 Conference for Computing in High-Energy and Nuclear Physics (CHEP 03), La Jolla, California, 24-28 Mar 2003, pp TUGT003* [arXiv:cs/0306029].
- [352] O. Barring *et al.*, “Towards automation of computing fabrics using tools from the fabric management workpackage of the EU DataGrid project,” *In the Proceedings of 2003 Conference for Computing in High-Energy and Nuclear Physics (CHEP 03), La Jolla, California, 24-28 Mar 2003, pp MODT004* [arXiv:cs/0305050].
- [353] R. Bramm *et al.* [ALICE Collaboration], “High-level trigger system for the LHC ALICE experiment,” *Nucl. Instrum. Meth. A* **502** (2003) 441.
- [354] R. Bramm *et al.* [ALICE Collaboration], “Online pattern recognition for the ALICE high level trigger,” *Nucl. Instrum. Meth. A* **502** (2003) 443.

Group N. Herrmann

- [355] X. Lopez *et al.*, “Subthreshold Production Of Sigma(1385) Baryons In Al + Al Collisions At 1.9a-GeV,” *Phys. Rev. C* **76** (2007) 052203.

BIBLIOGRAPHY

- [356] X. Lopez *et al.* [FOPI Collaboration], “Sub-threshold production of $\Sigma(1385)$ baryons in Al+Al collisions at 1.9A GeV,” arXiv:0710.5007 [nucl-ex].
- [357] M. Merschmeyer *et al.*, “K0 and Lambda production in Ni+Ni collisions near threshold,” Phys. Rev. C **76** (2007) 024906.
- [358] N. Bastid *et al.* [FOPI Collaboration], “K0 and Lambda production in Ni + Ni collisions near threshold,” arXiv:nucl-ex/0703036.
- [359] X. Lopez *et al.* [FOPI Collaboration], “Isospin dependence of relative yields of K+ and K0 mesons at 1.528-A-GeV,” Phys. Rev. C **75** (2007) 011901 [arXiv:nucl-ex/0701006].
- [360] V. Ammosov *et al.*, “Performance of RPC with low-resistive silicate glass electrodes exposed to Nucl. Instrum. Meth. A **576** (2007) 331.
- [361] M. Ciobanu *et al.*, “A front-end electronics card comprising a high gain/high bandwidth amplifier and a fast discriminator for time-of-flight measurements,” IEEE Trans. Nucl. Sci. **54** (2007) 1201.
- [362] A. Akindinov *et al.*, “RPC with low-resistive phosphate glass electrodes as a candidate for the Nucl. Instrum. Meth. A **572** (2007) 676 [arXiv:physics/0612083].
- [363] W. Reisdorf *et al.* [FOPI Collaboration], “Systematics of pion emission in heavy ion collisions in the 1-A-GeV regime,” Nucl. Phys. A **781** (2007) 459 [arXiv:nucl-ex/0610025].
- [364] A. Schuttauf *et al.*, “Performance Of The Multistrip-Mrpcs For Fopi,” Nucl. Phys. Proc. Suppl. **158** (2006) 52.
- [365] A. Andronic *et al.* [ALICE Collaboration], “Transition radiation spectra of electrons from 1-GeV/c to 10-GeV/c in regular and irregular radiators,” Nucl. Instrum. Meth. A **558** (2006) 516 [arXiv:physics/0511229].
- [366] C. Adler *et al.* [ALICE Collaboration], “Electron / pion identification with ALICE TRD prototypes using a neural network algorithm,” arXiv:physics/0506202.
- [367] N. Bastid *et al.* [FOPI Collaboration], “First analysis of anisotropic flow with Lee-Yang zeroes,” Phys. Rev. C **72** (2005) 011901 [arXiv:nucl-ex/0504002].
- [368] B. Hong *et al.* [FOPI Collaboration], “Charged pion production in (44)Ru-96 + (44)Ru-96 collisions at 400-A-MeV and 1528-A-MeV,” Phys. Rev. C **71** (2005) 034902 [arXiv:nucl-ex/0501021].

BIBLIOGRAPHY

- [369] C. Adler *et al.* [ALICE Collaboration], “Position reconstruction in drift chambers operated with Xe, CO-2 (15%),” Nucl. Instrum. Meth. A **540** (2005) 140 [arXiv:physics/0511233].
- [370] C. Adler *et al.* [ALICE Collaboration], “Electron / pion identification with ALICE TRD prototypes using a neural network algorithm,” Nucl. Instrum. Meth. A **552** (2005) 364.
- [371] A. Andronic *et al.* [FOPI Collaboration], “Excitation function of elliptic flow in Au + Au collisions and the nuclear matter equation of state,” Phys. Lett. B **612** (2005) 173 [arXiv:nucl-ex/0411024].
- [372] N. Bastid *et al.*, “Shape parameters of the participant source in Ru+Ru collisions at 400A MeV,” Nucl. Phys. A **742** (2004) 29.
- [373] R. Kotte *et al.* [FOPI Collaboration], “Two-proton small-angle correlations in central heavy-ion collisions: A beam energy and system-size dependent study,” Eur. J. Phys. A **23** (2005) 271 [arXiv:nucl-ex/0409008].
- [374] W. Reisdorf *et al.* [FOPI Collaboration], “Droplet formation in expanding nuclear matter: A system-size dependent study,” Phys. Lett. B **595** (2004) 118 [arXiv:nucl-ex/0405014].
- [375] O. Busch *et al.* [ALICE TRD Collaboration], “Transition radiation spectroscopy with prototypes of the ALICE TRD,” Nucl. Instrum. Meth. A **522** (2004) 45 [arXiv:physics/0404106].
- [376] W. Reisdorf *et al.* [FOPI Collaboration], “Nuclear stopping from 0.09-A-GeV to 1.93-A-GeV and its correlation to flow,” Phys. Rev. Lett. **92** (2004) 232301 [arXiv:nucl-ex/0404037].
- [377] A. Andronic *et al.* [ALICE Collaboration], “Space charge in drift chambers operated with the Xe,CO-2(15Nucl. Instrum. Meth. A **525** (2004) 447 [arXiv:physics/0402043].
- [378] G. Stoicea *et al.* [FOPI Collaboration], “Azimuthal dependence of collective expansion for symmetric heavy ion collisions,” Phys. Rev. Lett. **92** (2004) 072303 [arXiv:nucl-ex/0401041].
- [379] N. Herrmann and K. Wisniewski [FOPI Collaboration], “Hadronic matter properties from the reaction studies at SIS,” Acta Phys. Polon. B **35** (2004) 1091.
- [380] A. Andronic *et al.* [ALICE Collaboration Collaboration], “Energy loss of pions and electrons of 1-GeV/c to 6-GeV/c in drift chambers operated with Xe,CO-2(15Nucl. Instrum. Meth. A **519** (2004) 508 [arXiv:physics/0310122].

BIBLIOGRAPHY

- [381] A. Andronic *et al.* [ALICE Collaboration], “Pulse height measurements and electron attachment in drift chambers operated with Xe, CO-2 mixtures,” Nucl. Instrum. Meth. A **498** (2003) 143 [arXiv:physics/0303059].
- [382] A. Andronic *et al.* [FOPI Collaboration], “Directed flow in Au+Au, Xe+CsI and Ni+Ni collisions and the nuclear Phys. Rev. C **67** (2003) 034907 [arXiv:nucl-ex/0301009].
- [383] A. Mangiarotti *et al.*, “Sub-threshold phi meson yield in central Ni-58 + Ni-58 collisions,” Nucl. Phys. A **714** (2003) 89.
- [384] M. Petrovici *et al.*, “Multistrip multigap symmetric RPC,” Nucl. Instrum. Meth. A **508** (2003) 75.